

HITACHI

airCore 700

R32 Single Split Systems

Ducted | Cassette | Ceiling Suspended



WARRANTY

Cooling & Heating



Hitachi provides a comprehensive range of split air conditioning systems designed for various applications, catering to both light commercial projects and residential settings.

The new light commercial split system, **airCore 700**, incorporates features that offer superior comfort, achieve outstanding energy efficiency, simplify installation, and streamline maintenance. This ensures a superior living experience for users and provides convenience for professionals. Building owners and tenants will appreciate the diverse range of indoor unit design options that seamlessly blend into any interior space.



HOME



RESTAURANT



RETAIL



NURSING HOME



CLASSROOM



OFFICE



CLINIC



LIBRARY



DATA CENTRE

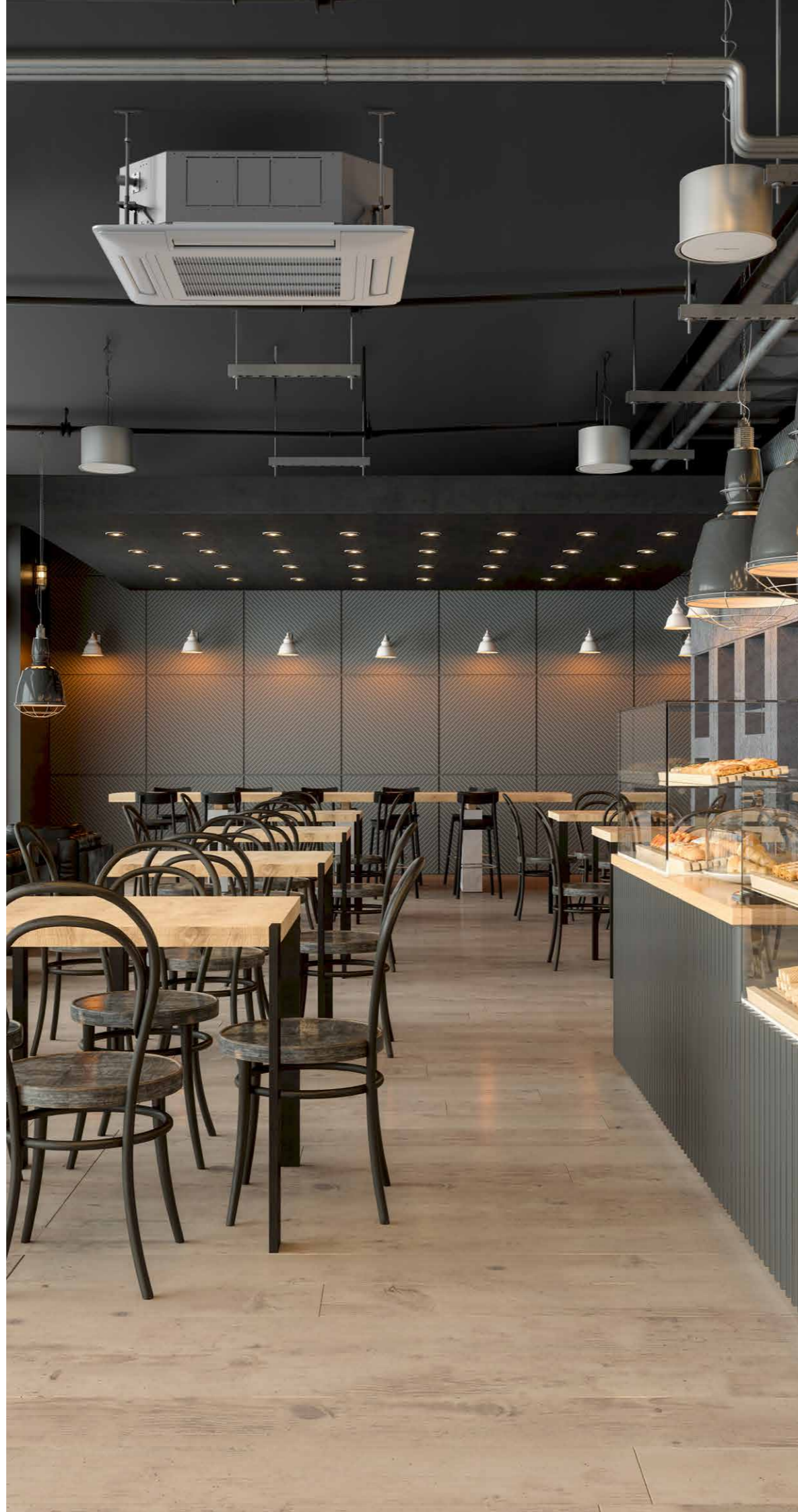

Index

Product Lineups

Outdoor Units

- 09 | High ambient performance
- 11 | Higher efficiency, lower GWP
- 13 | Smarter design, easier life
- 15 | Premium Zoning Ducted Systems

Indoor Units

















- 21 | Ducted
- 25 | Cassette
- 36 | Ceiling suspended

Controllers & Apps

- 38 | Individual controllers
- 42 | Apps
- 45 | Integrate with BMS
- 47 | H-LINK Integration

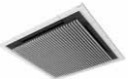
Specifications

Product Lineups

Rated Capacity (Cooling/Heating)		5.0/6.0kW	6.0/7.5kW	7.2/8.6kW	10.0/11.5kW	12.5/14.0kW	14.0/16.0kW	16.0/18.0kW
Outdoor Units	PAS-*UFASNQ1 (single phase) PAS-*UFASMQ1 (three phase)	 PAS-2.0UFASNQ1	 PAS-2.5UFASNQ1	 PAS-3.0UFASNQ1	 PAS-4.0UFASNQ1 PAS-4.0UFASMQ1	 PAS-5.0UFASNQ1 PAS-5.0UFASMQ1	 PAS-6.0UFASNQ1 PAS-6.0UFASMQ1	 PAS-6.5UFASNQ1 PAS-6.5UFASMQ1
Ducted	MSP	 PPIM-2.0UFA1NQ	 PPIM-2.5UFA1NQ	 PPIM-3.0UFA1NQ	 PPIM-4.0UFA1NQ	 PPIM-5.0UFA1NQ	 PPIM-6.0UFA1NQ	
	HSP			 PPIH-3.0UFA1NQ	 PPIH-4.0UFA1NQ	 PPIH-5.0UFA1NQ	 PPIH-6.0UFA1NQ	 PPIH-6.5UFA1NQ
Indoor Units	Standard Panel	 PCI-2.0UFA1NQ	 PCI-2.5UFA1NQ	 PCI-3.0UFA1NQ	 PCI-4.0UFA1NQ	 PCI-5.0UFA1NQ	 PCI-6.0UFA1NQ	 PCI-6.5UFA1NQ
	Cassette	 P-AP160NAE2*EX	 P-AP160NAE2*EX	 P-AP160NAE2*EX	 P-AP160NAE2*EX	 P-AP160NAE2*EX	 P-AP160NAE2*EX	 P-AP160NAE2*EX
	Silent Iconic Panel (optional)	 P-GP160NAPU*EX	 P-GP160NAP*EX	 P-GP160KAP*EX		 P-GP160NAPU*EX	 P-GP160NAP*EX	 P-GP160KAP*EX
Ceiling Suspended	 PPFC-2.0UFA1NQ	 PPFC-2.5UFA1NQ	 PPFC-3.0UFA1NQ	 PPFC-4.0UFA1NQ	 PPFC-5.0UFA1NQ	 PPFC-6.0UFA1NQ		

Outdoor units

- 06 | Lineup
- 07 | A glance at new technologies and features
- 09 | High ambient performance
- 11 | Higher efficiency, lower GWP
- 13 | Smarter design, easier life
- 15 | Premium zoning ducted system

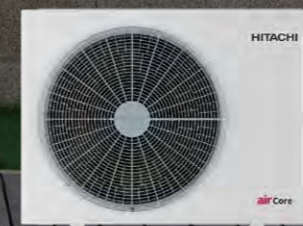

5.0kW, 6.0kW, 7.2kW

PAS-2.0UFASNQ1
PAS-2.5UFASNQ1
PAS-3.0UFASNQ1

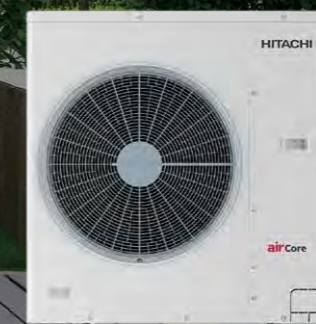

10.0kW

PAS-4.0UFASNQ1
PAS-4.0UFASMQ1



12.5kW, 14.0kW, 16.0kW

PAS-5.0UFASNQ1
PAS-5.0UFASMQ1
PAS-6.0UFASNQ1
PAS-6.0UFASMQ1
PAS-6.5UFASNQ1
PAS-6.5UFASMQ1

Outdoor units

A GLANCE AT NEW TECHNOLOGIES AND FEATURES

Fan design

- Adopt DC motor with 16 speed control, more energy saving and higher energy efficiency.

Superior compressor and pre-heating function

- Adopt new R32 DC inverter compressors that incorporates Hitachi's exclusive compressor control technology.
- Uses advanced multi-pulse control induction on coil, core, rotor and stator, eliminating use of external crankcase heater
- Enhances efficiency of pre-heating in low ambient conditions and reduces startup time

Fan grille design

- Discover a whole new level of performance with better heat dissipation and a modern look

Easy installation and maintenance

- Piping options in 4 directions: depending on the installation situation, installers can choose from 4 running pipe directions.
- Easier removal of front service cover: the screws you need to open/close the front service cover are all on the front side.

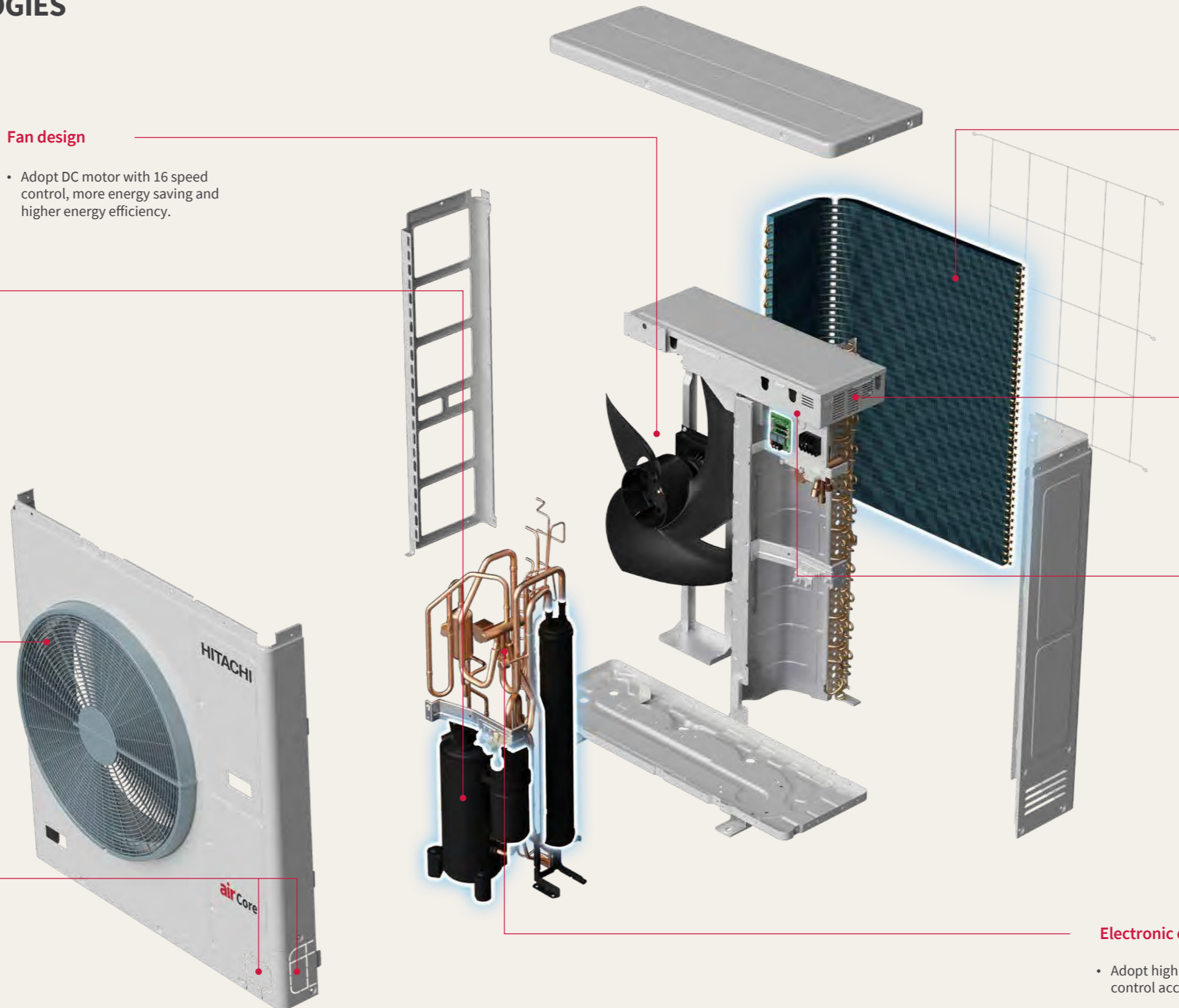

Excellent heat exchanger design

- Features a newly improved refrigerant path and a new fin shape, make the unit more efficient.

New printed circuit board

- With Hitachi's exclusive compressor control technology, operation is more comfortable and consistent.

Electrical box protection

- Equipped with advanced electrical box protection, which is vital for safety as it prevents dust, moisture, and physical damage, ensuring proper function, easier maintenance, compliance with regulations, and ultimately extends component lifespan.

Electronic expansion valve

- Adopt high precision electronic expansion valves for higher control accuracy and more accurate temperature control.

Product features

New Fan and Fan Grille Design

airCore 700 features both an enhanced fan and fan grille design compared to the previous generation product. The upgraded design not only improves heat discharge but also enhances the overall appearance, meeting the stringent requirements of engineers, business owners, and designers alike.

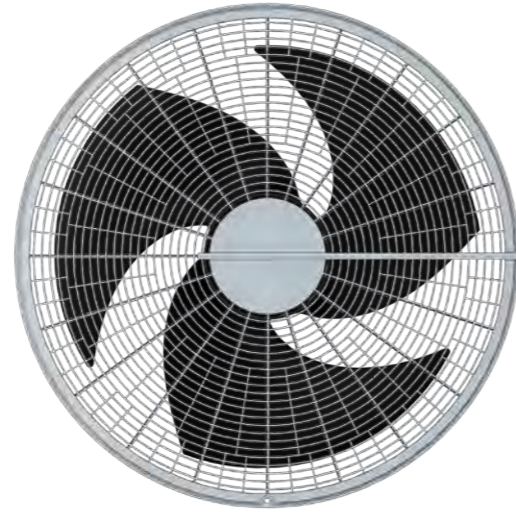

Excellent Heat Exchanger Design

Features a newly improved refrigerant path and a new fin shape, make the unit more efficient.

Wide Operation Range

Cooling operation temperature range: -5~52°C
 Heating operation temperature range: -15~15.5°C
 Wide operation range to meet the needs of different environments.

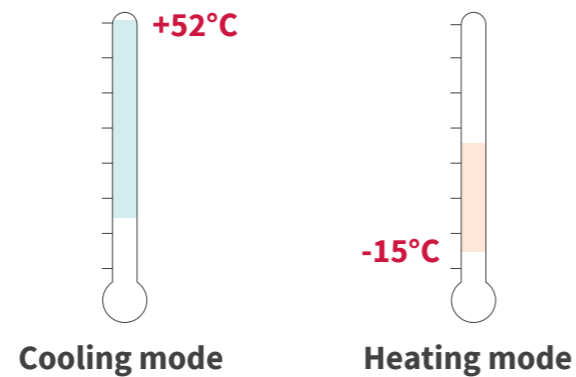

Superior Compressor and Pre-heating Function

- Adopting a new R32 DC inverter compressor results in greater energy efficiency.
- Pre-heating the compressor in low ambient conditions is accomplished through advanced multi-pulse control applied to the induction coil, core, rotor, and stator, eliminating the need for an external crankcase heater. This improvement enhances the efficiency of pre-heating in low ambient and reduces startup time.

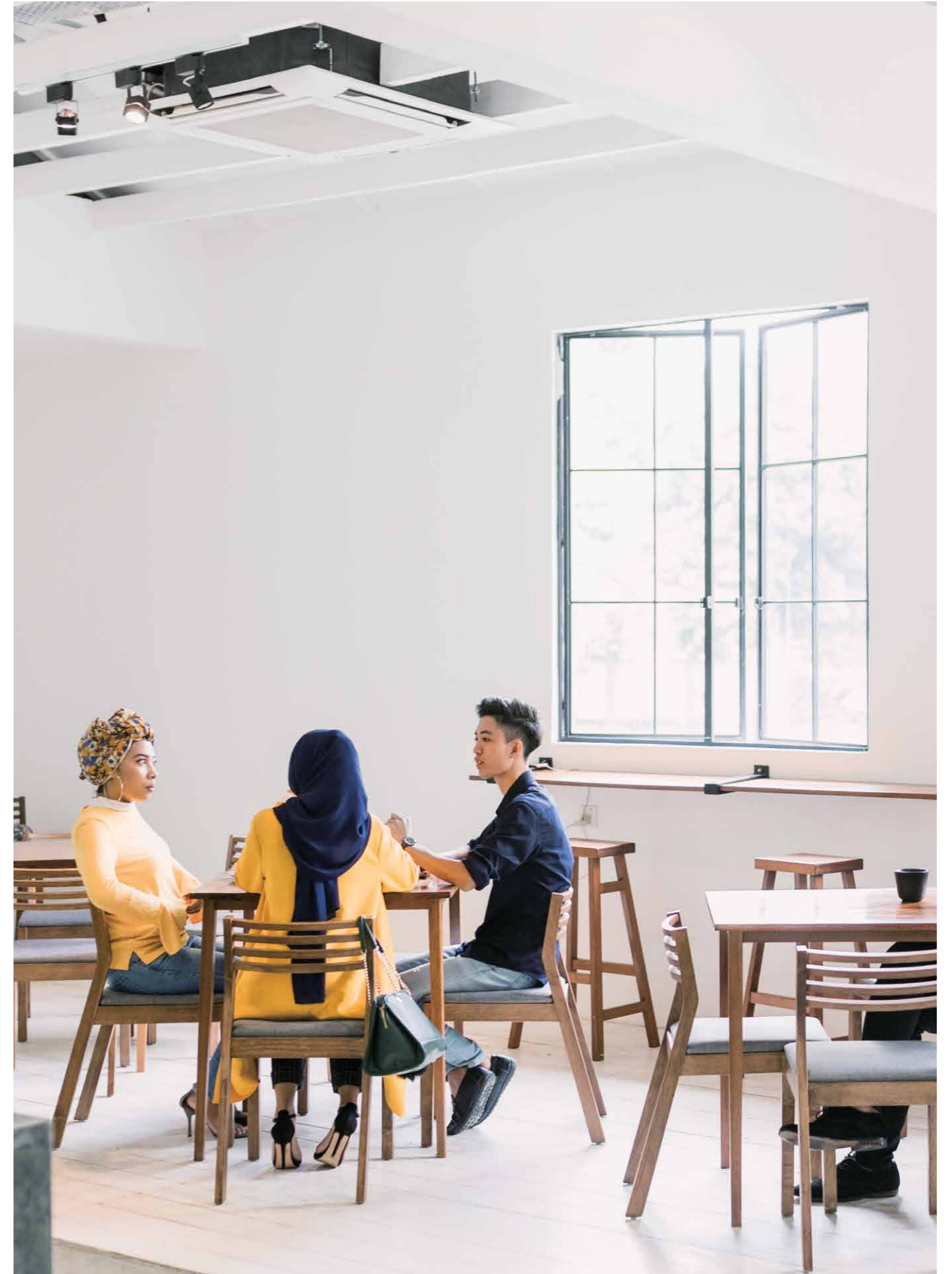

R32 low GWP Refrigerant

Hitachi is committed to reducing the environmental impact of its products by using refrigerants with low Global Warming Potential (GWP). The **airCore 700** split systems utilize R32, a low GWP refrigerant, as a replacement for the older R410a refrigerant. R32 offers improved energy efficiency and reduces emissions, allowing for smaller, more compact air conditioning systems that require less refrigerant overall. Its GWP is 675, significantly lower than that of R410a.

	Ozone Depletion Potential	Global Warming Potential
R32	0	675
R410A	0	2,090
R22	0.05	1,810

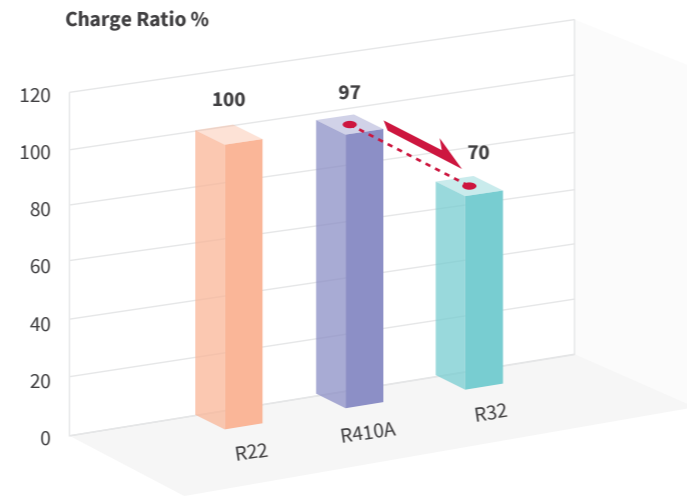

Comparing refrigerant charge against R22.

Energy Efficiency

airCore 700 has high energy efficiency. EER up to 4.39. COP up to 4.69.

MSP Ducted unit

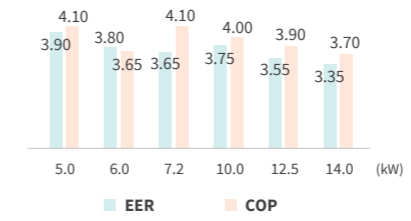

HSP Ducted unit

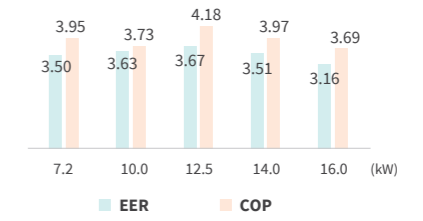

Cassette unit

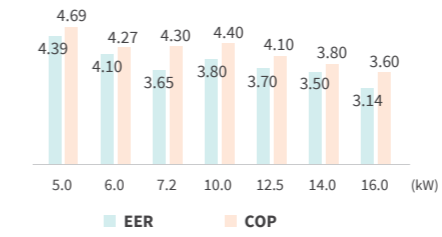

Ceiling Suspended unit

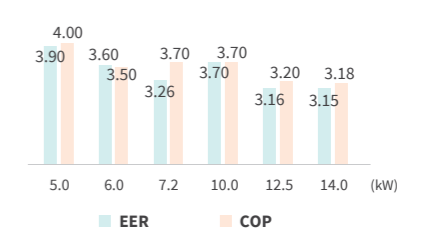

Notes: The charts indicate the highest EER and COP of each model.

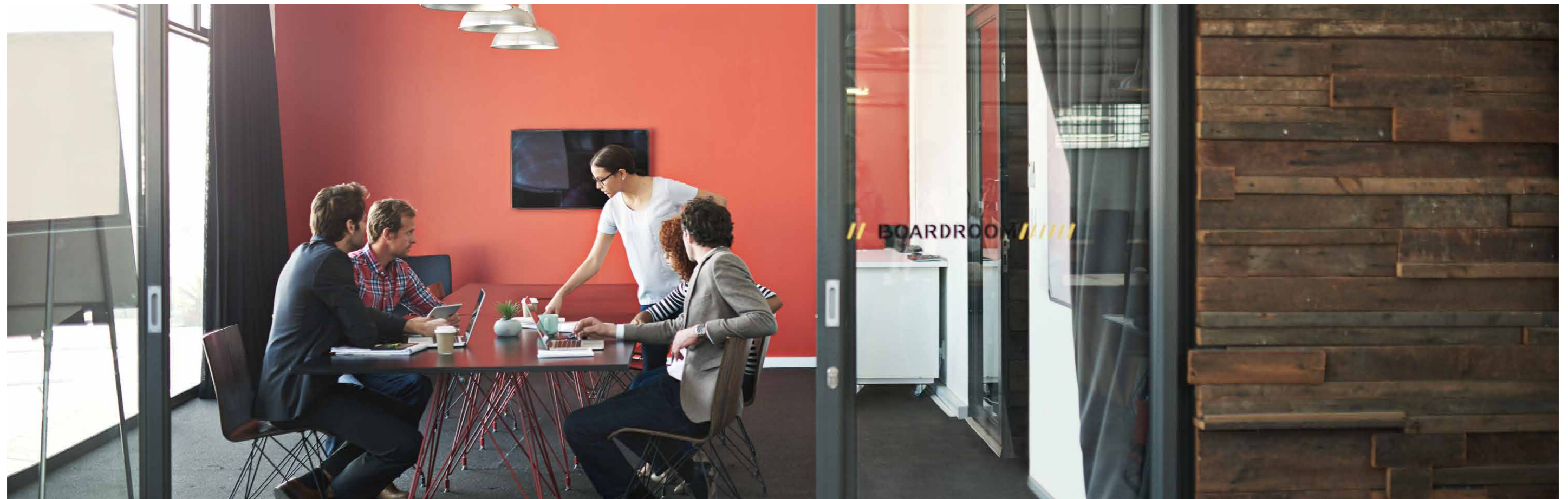

Flexibility for Easy Maintenance

The outdoor unit of **airCore 700** is designed with piping options available in four directions, allowing for flexible installation based on the specific situation. Installers have the choice of four running pipe direction options, providing adaptability for various installation scenarios. Additionally, the unit features an improved front service cover removal design; all the screws required to open or close the front service cover are conveniently located on the front side.

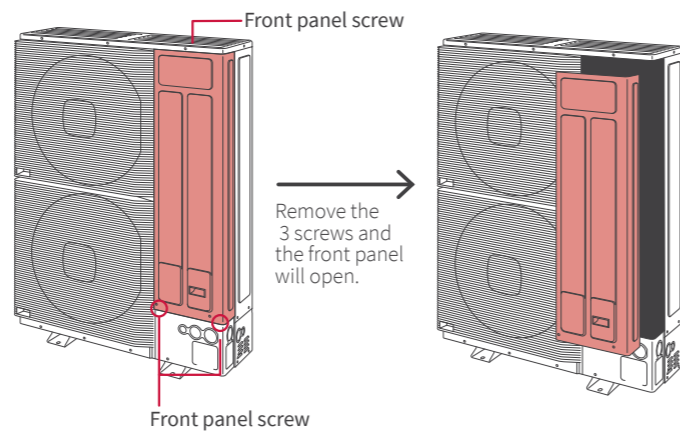
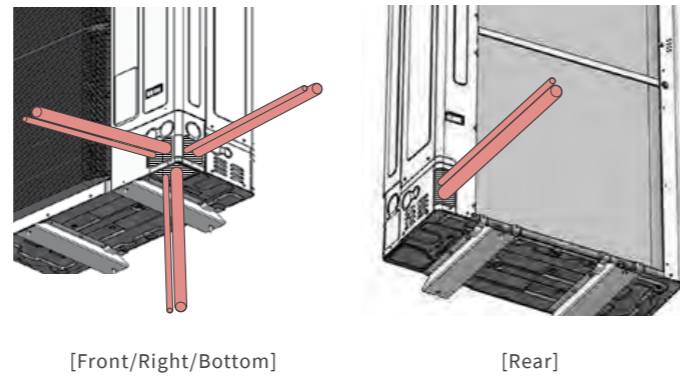

Electrical Box Protection

Electrical box protection is vital for safety. Hitachi **airCore 700**, equipped with electrical box protection that can prevent dust, moisture, and physical damage, ensures proper function and easier maintenance, and, of course, meets compliance with regulations. Ultimately, it achieves the extension of the component lifespan.

Capable of Demand Response

- Interface provided for connection to DRED by the electrical utility provider.
- Capable of three modes: DRM1, DRM2, DRM3.
- Able to activate these modes accordingly during periods of peak electricity demand.



Night Quiet Operation

airCore 700 significantly reduces the noise levels of the outdoor unit and offers the feature to schedule night quiet operation is available for all indoor unit types. The sound power level has decreased to **49dB**. (MSP Model 5.0kW~7.2kW)



Long Piping and Large Height Difference

Accommodating up to **75m** of piping run and **30m** in height, this offers a great deal of flexibility in terms of installation.

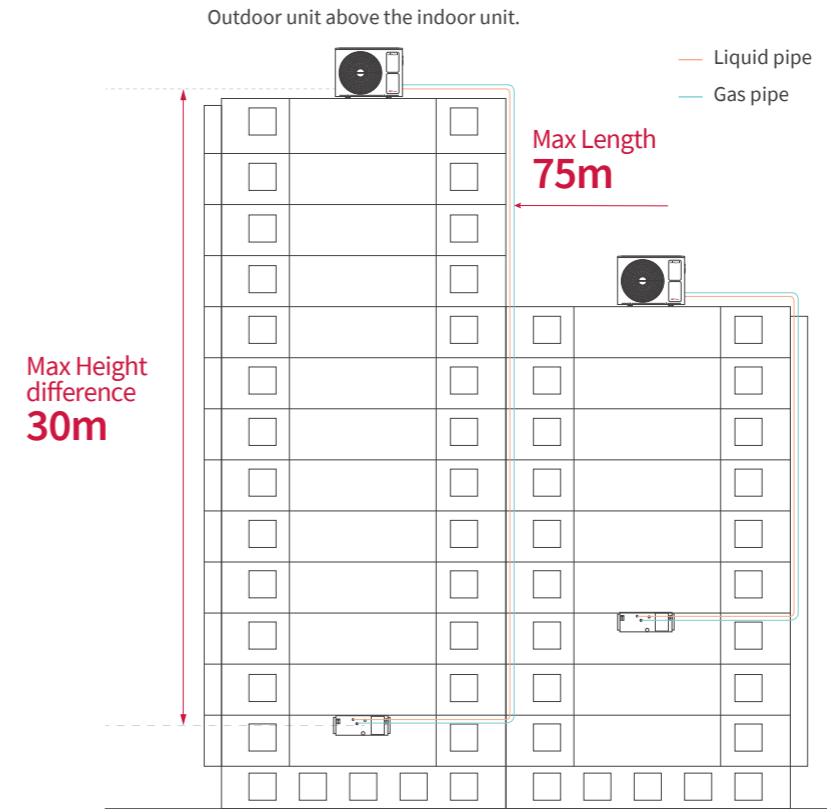

Note: only available to model 7.2~16.0kW

MSP Ducted							
Piping	Model (kW)	5.0	6.0	7.2	10.0	12.5	14.0
Diameter (Liquid)	mm	Φ6.35	Φ6.35	Φ6.35	Φ9.52	Φ9.52	Φ9.52
Diameter (Gas)	mm	Φ12.7	Φ12.7	Φ12.7	Φ15.88	Φ15.88	Φ15.88
Max Length	m	50	50	75	75	75	75
Max Height	m	30	30	30	30	30	30

HSP Ducted						
Piping	Model (kW)	7.2	10.0	12.5	14.0	16.0
Diameter (Liquid)	mm	Φ6.35	Φ9.52	Φ9.52	Φ9.52	Φ9.52
Diameter (Gas)	mm	Φ12.7	Φ15.88	Φ15.88	Φ15.88	Φ15.88
Max Length	m	75	75	75	75	75
Max Height	m	30	30	30	30	30

Outdoor units

PREMIUM ZONING DUCTED SYSTEM

The premium zoning kit is compatible with the airCore 700 ducted system, designed for both medium ESP and high ESP indoor units.

Realising individual zone control

Allow the connection of up to 8 zones. Possible to connect each zone with thermostat for individual room set point temperatures.

Optimises airflow into each zone

Optimising comfort with modulating damper control for each zone and regulates airflow based on set point temperature on thermostat.

Zoning Control

- Wired remote controller (WRC, PC-ARFG2-Z) enables central control of all zones through the **premium zoning system**. When enabled, the home screen with zone control icon and set temperature in each zone will be displayed.
- **Monitoring all individual zone status** is available from the zone control screen. ON/OFF, set temperature, fan speed can be set for each individual zone from WRC.
- **Weekly operation schedule** can be set to control the zoning system. Individual zones can be selected to program different operation times and temperatures in each.

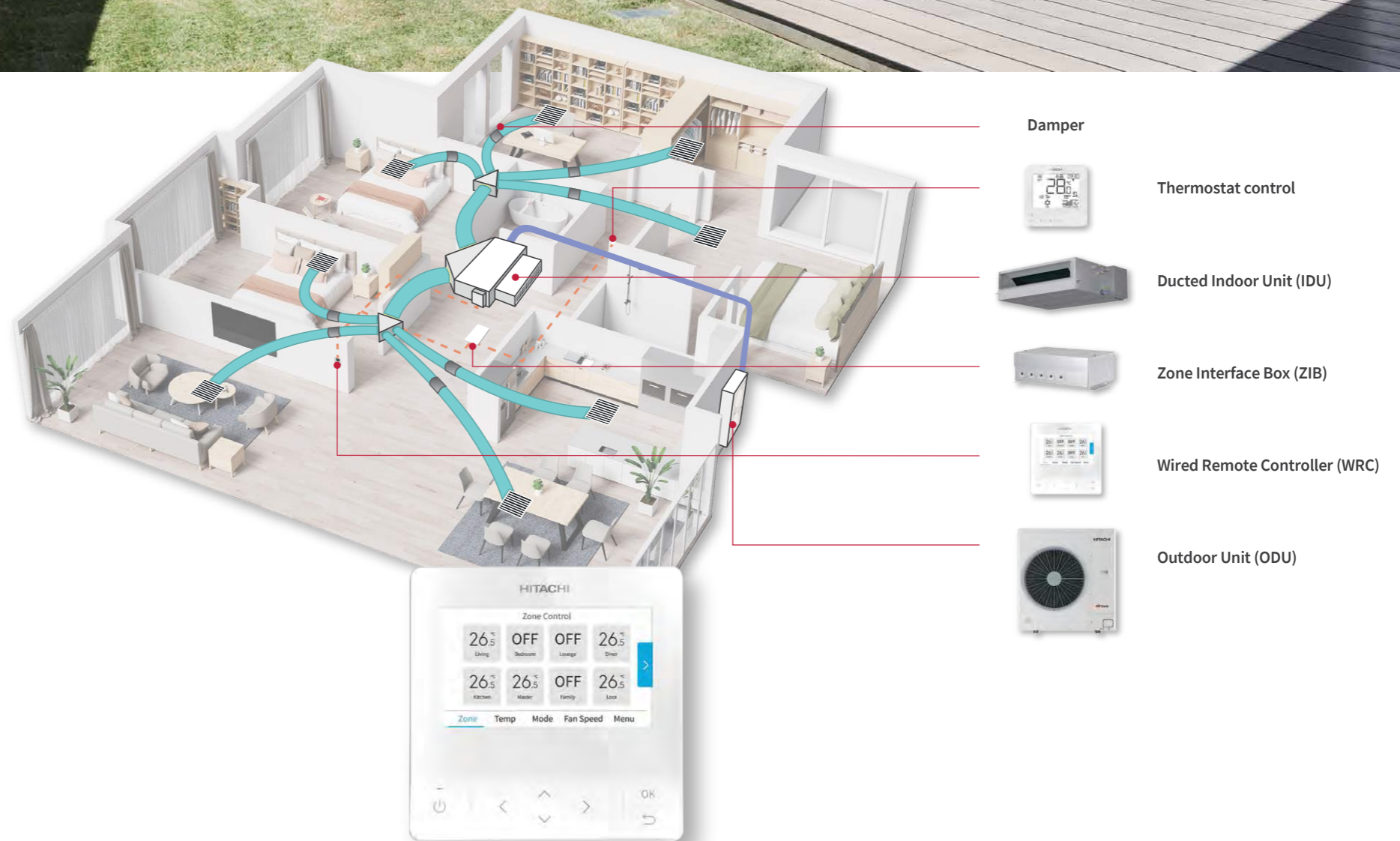

Apps



airCloud Go



Remotely control premium zoning system by airCloud Go.

- Control your AC from anywhere
- 7-Day operation schedule
- Control each individual zone

*coming soon

Indoor units

19 | FrostWash

21 | Ducted

- 21 | Lineup
- 22 | Ducted
- 23 | HSP Ducted

25 | Cassette

- 25 | Lineup
- 26 | 4-way Cassette, Standard
- 27 | Silent Iconic Panel (optional)
- 29 | Human Sensor Panel (optional)

36 | Ceiling Suspended



FrostWash™

Now available on airCore 700 Indoor Units

All indoor units including ducted, cassette, and ceiling suspended systems, are equipped with Frostwash™. This allows the unit to freeze dirt and dust trapped in the heat exchange of the indoor unit, and then defrost it and dry it – effectively cleaning the hex and helping to safeguard long-term performance by maintaining good airflow.



How does it work?

- FrostWash™ freezes the heat exchanger, capturing the dirt.
- When the frost melts, the dirt detaches from the fins.
- As a result, the air volume can be maintained over time, which contributes to a sustainable performance of the indoor unit and comfort.

FrostWash™ process can be activated manually or automatically at scheduled intervals.

* 1 Dirt removal depends on the usage environment.

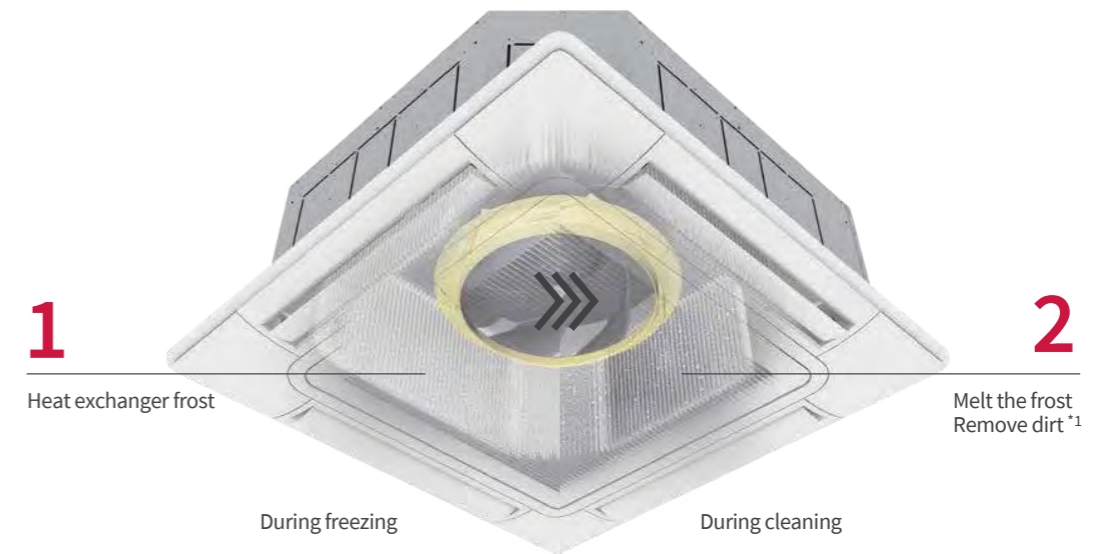

Frostwash™ helps to maintain airflow performance

With Frostwash™ through the freezing defrosting and drying process, any dust and pollutants collected on the coil are discharged outside along with the condensate water, effectively maintaining the airflow performance of the indoor unit.

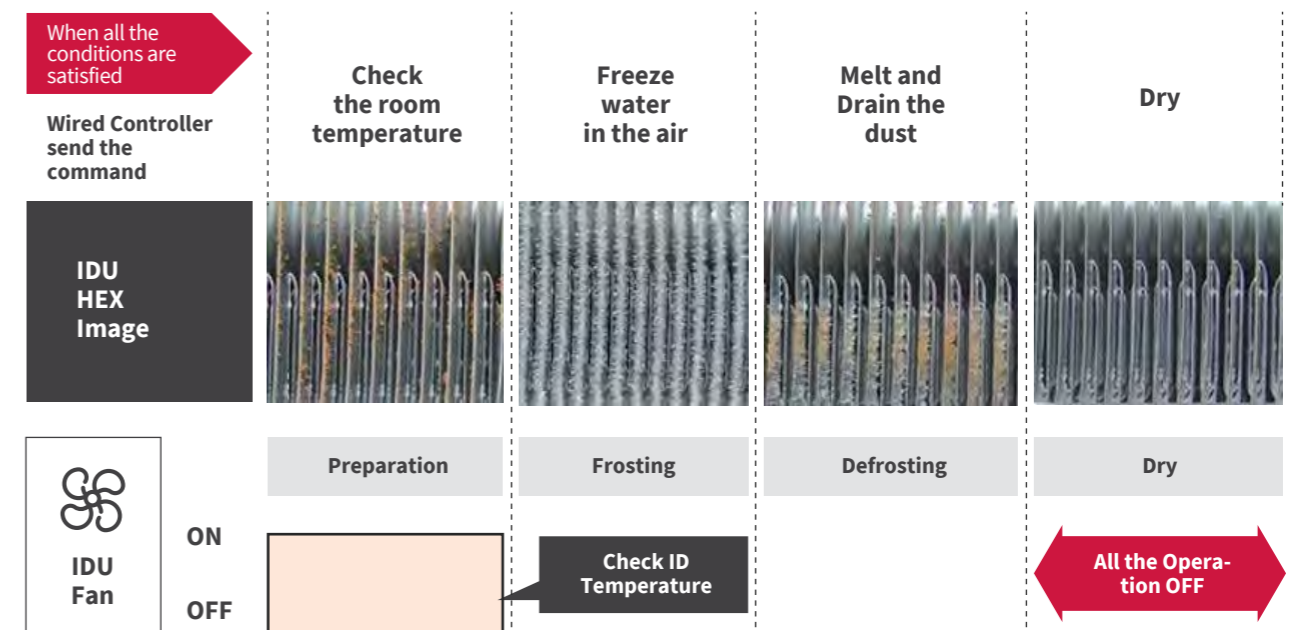

Indoor units

DUCTED | LINEUP

MSP Ducted (ESP range: 35~215Pa)



PPIM-2.0UFA1NQ
PPIM-2.5UFA1NQ

5.0kW, 6.0kW



PPIM-3.0UFA1NQ

7.2kW



PPIM-4.0UFA1NQ
PPIM-5.0UFA1NQ
PPIM-6.0UFA1NQ

10.0kW, 12.5kW, 14.0kW

HSP Ducted (ESP range: 35~310Pa)



PPIH-3.0UFA1NQ
PPIH-4.0UFA1NQ

7.2kW, 10.0kW



PPIH-5.0UFA1NQ
PPIH-6.0UFA1NQ
PPIH-6.5UFA1NQ

12.5kW, 14.0kW, 16.0kW

Indoor units

DUCTED

Wide ESP range up to 310Pa

airCore 700 offers both mid and high static pressure ducted systems, providing for a wide range of ducted layouts and applications. The mid-ESP variant is designed to handle an ESP range of 35~215Pa, while the high-ESP models are designed to handle an ESP range of 35~310Pa.

A wide ESP range means **airCore 700** is suitable for spaces with many discrete areas, including corners and recesses. Multiple outlets can be connected to the ducted unit to ensure a uniform gust of air around a complex space. A system can be set up in a short time and will run reliably into the future.

For example: Lower ESP application

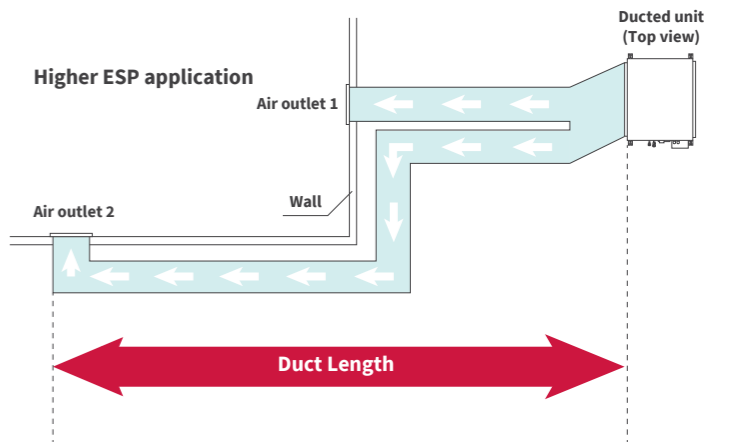
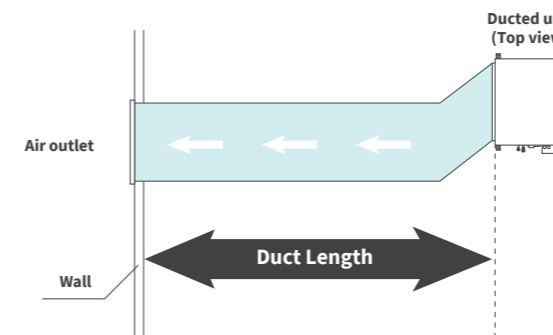

Automatic ESP Adjustment

Allow automatic setting of ESP level and ensure matching the corresponding fan speed according to the identified external static pressure and achieve rated airflow within 10% range.
(setting via Service Menu in wired remote controller during commissioning)

Quiet Operation

The well-balanced centrifugal fan provides a quiet and efficient operation.



Indoor units

DUCTED | HSP DUCTED

High Performance

Enhanced efficiency DC fan motor paired with a powerful centrifugal fan for high airflow delivery.

HESP Ducted Indoor Units

airCore 700 high-ESP ducted indoor units are designed to be easily separable. The fan cover can be effortlessly removed from the heat exchanger compartment and reassembled with just a simple "one click" mechanism.

These units come equipped with a receiver connector for a float switch and temperature sensor. By unplugging the connector, the main PCBA, fan motor wiring, and receiver become easily accessible for connection.

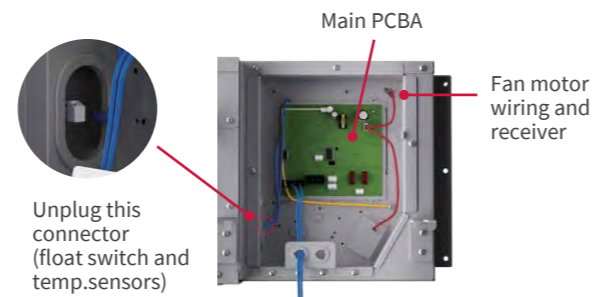

This disassembled design offers an ideal solution for installations in crowded or confined spaces, such as rooftop attics, as well as narrow and elongated spaces. It greatly facilitates the delivery and installation process, making it more convenient and feasible.

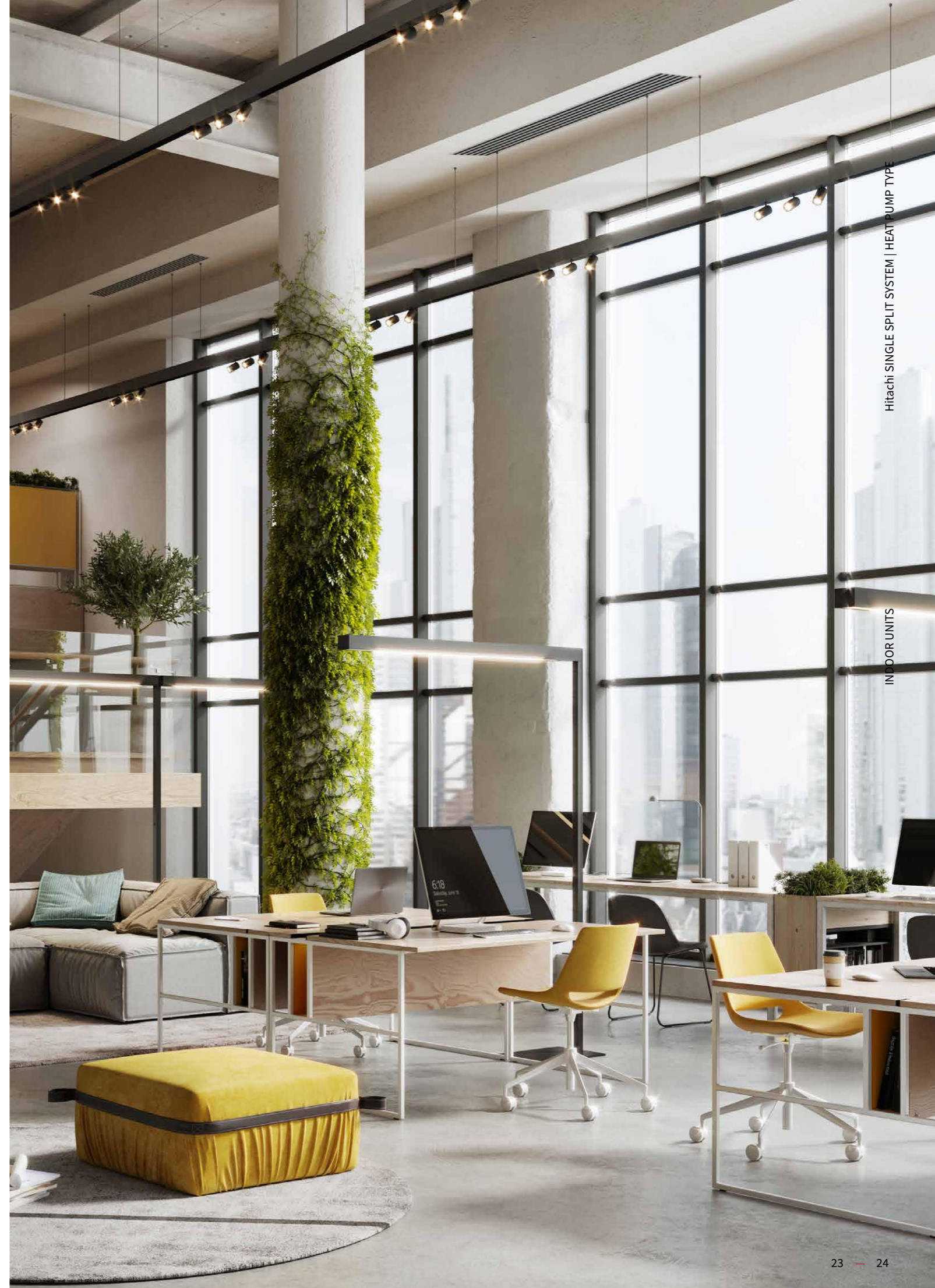
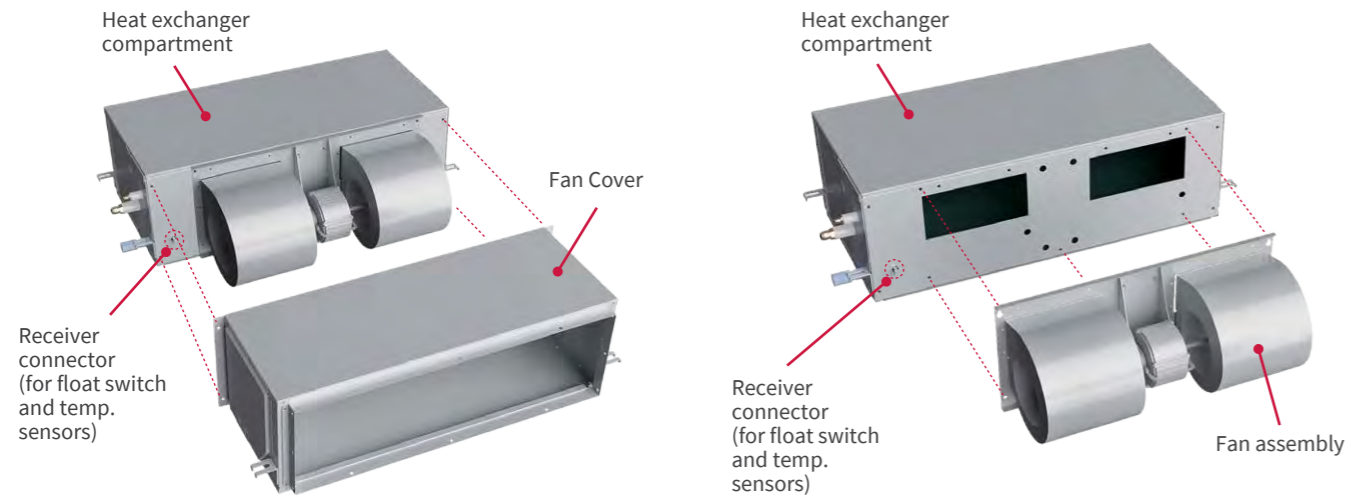

Hitachi SINGLE SPLIT SYSTEM | HEAT PUMP TYPE

INDOOR UNITS

Indoor units

CASSETTE | LINEUP

4-WAY CASSETTE Standard Panel

PCI-2.0UFA1NQ
PCI-2.5UFA1NQ
PCI-3.0UFA1NQ



PCI-4.0UFA1NQ
PCI-5.0UFA1NQ
PCI-6.0UFA1NQ
PCI-6.5UFA1NQ



Black Panel option



4-WAY CASSETTE Silent Iconic Panel (optional)

Silent Iconic Panel
(White, Elevating Grille)

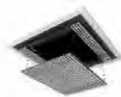

Silent Iconic Panel
(White)

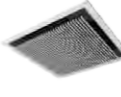

Silent Iconic Panel
(Black)

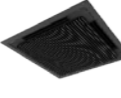

4-WAY CASSETTE Human Sensor Panel (optional)



P-AP160NAE2*EX
(Standard with Human Sensor Panel)

Indoor units

CASSETTE | 4-WAY CASSETTE, STANDARD

Airflow can be controlled by adjusting four louvre individually

A comfortable air-conditioned environment can be achieved through various louvre settings, which are available when combined with the wired controller. Air conditioning comfort is enhanced by using a louvre control function to adjust louvres individually for better control of airflow direction. One option adjusts the louvre horizontally to prevent direct airflow towards individuals, while another option provides individual swing operation to ensure optimal airflow distribution.

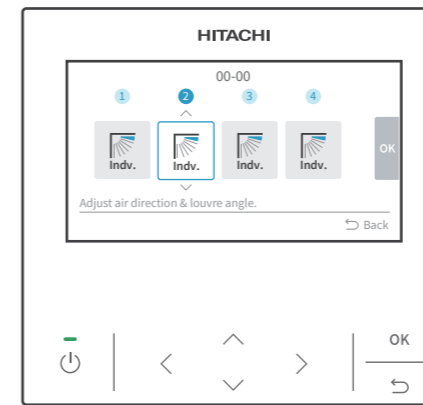

Easy setting of each louvre
airflow direction using Wired
Controller

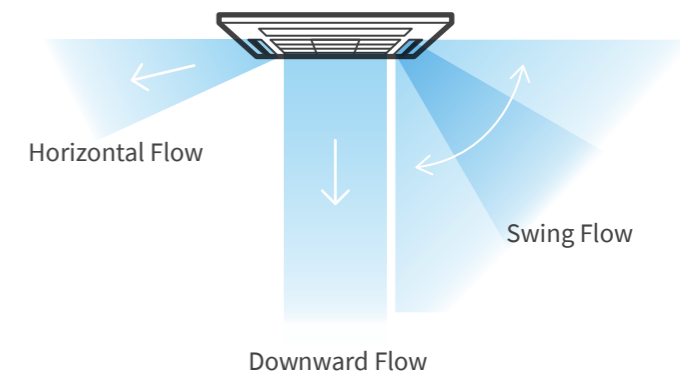

The airflow direction can be selected according to the situation.

Example 1: At Front Desk

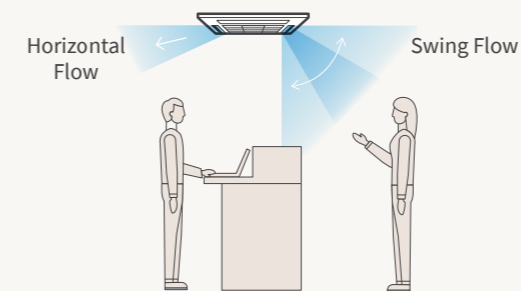

Example 2: At Office

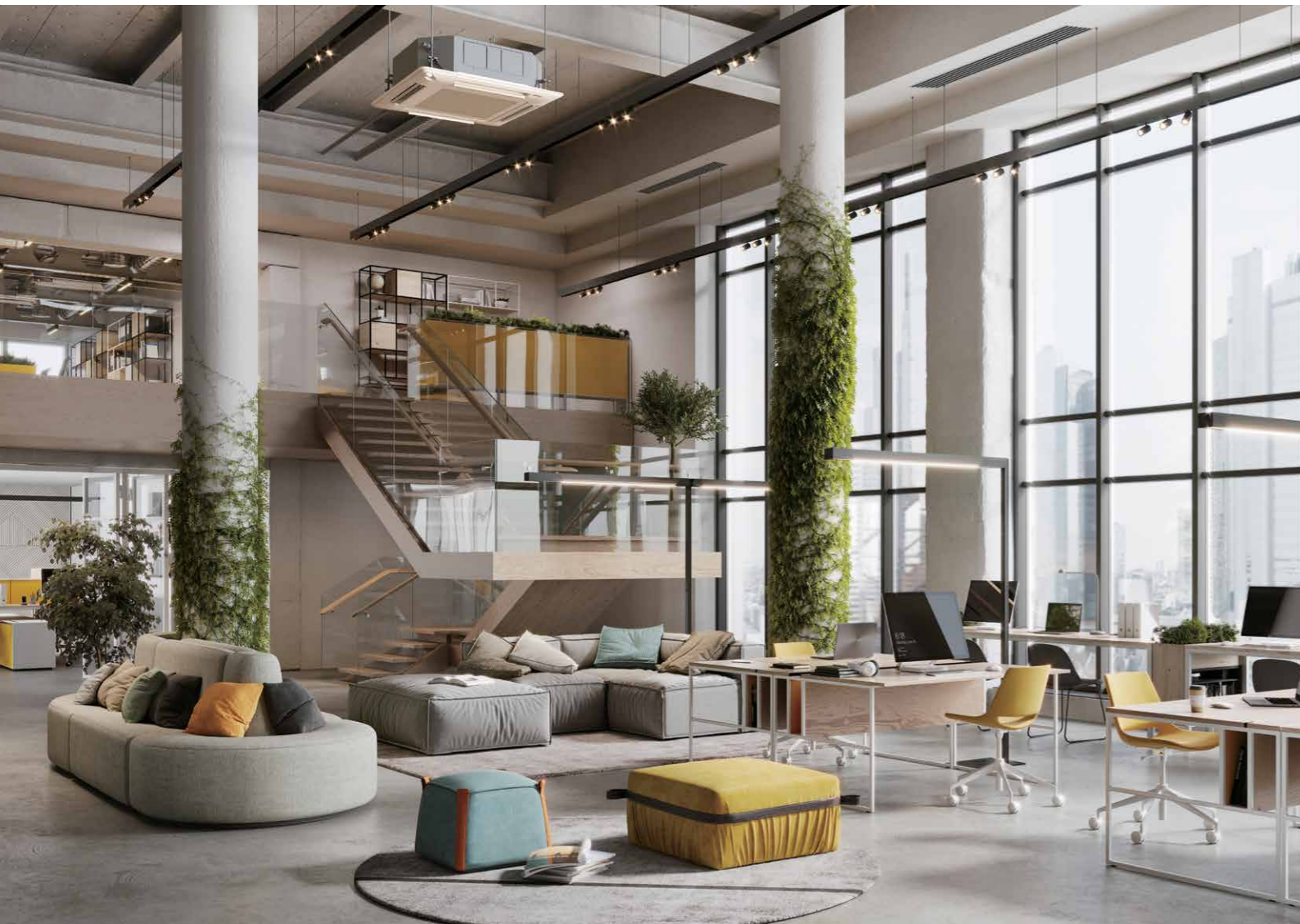
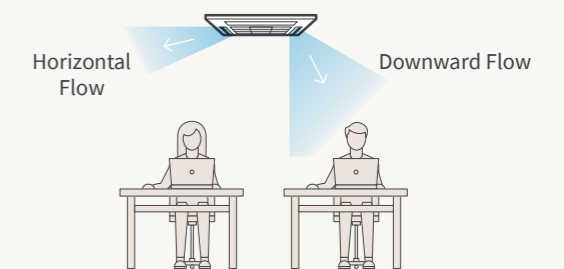

Indoor units

CASSETTE | SILENT ICONIC PANEL (OPTIONAL)

Silent-Iconic™

4-way Cassette Design Panel

A cassette panel that offers design integration as discreet as a more expensive ducted system



iF Design Award 2020
Award Winning
(Discipline: Product)

A new option

"Silent-Iconic"

Designed to match the interior, in harmony with the space. Compared with the ceiling-duct-type, the installation cost can be reduced.



The traditional selection

Ceiling Mounted Duct Type

Using this type, you can create a sense of luxury without being noticeable, but its construction costs are relatively high.



or

4-way Cassette type

Although the installation cost can be reduced, it may be difficult to match with the surrounding space due to the large presence of the indoor unit.



The design is well-matched to the space

It is designed to harmonize with the space by using a discrete low-profile air grille and darkening the contact space between the grille and the unit frame.

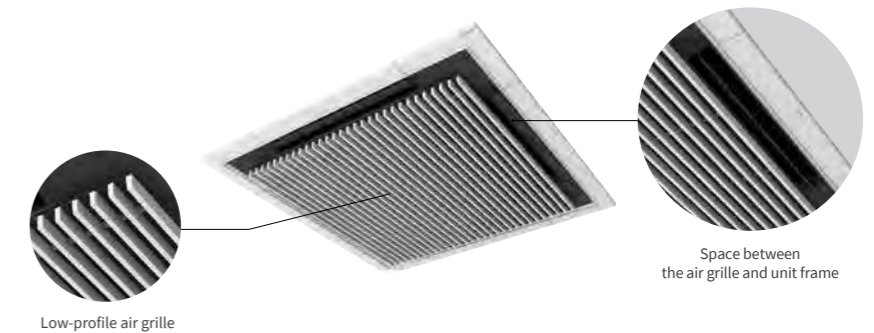

Low-profile air grille

Space between the air grille and unit frame



It is easy to clean the filter

It is easy to clean the filter by using the selecting the option with the elevation grille which enables the air grille to be lowered to floor level for cleaning through the use of a powered motor.

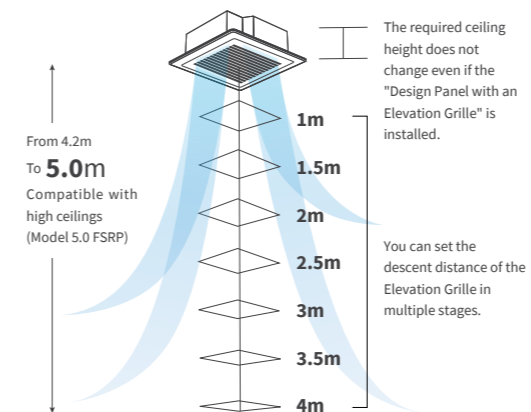

It is easy to install

The sliding corners make it easier to fasten the panel to the ceiling surface using screws.



Indirect airflow option

Using the compatible controller and motion sensor kit, users may select from direct or indirect airflow: indirect airflow detects the presence of people in the space and directs airflow around them so they do not directly feel the airflow.

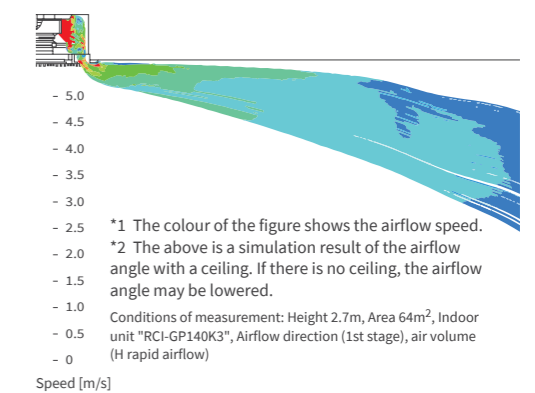

Connection with ceiling surface

By using a low-profile frame connected to the ceiling, the unit is less visible, and harmonization with the ceiling surface is further enhanced.



Silent-Iconic 4-way Cassette Design Panel

Indoor units

CASSETTE | HUMAN SENSOR PANEL (OPTIONAL)

Let occupants choose whether they want to directly feel airflow

The presence of occupants is detected through a motion sensor which divides the room into 4 zones – one for each louvre. For each of the 4 zones served by a cassette, air can be served either Direct or Indirect. Therefore one zone could receive direct airflow while another has indirect airflow, catering for different personal preferences of people occupying the same area.

- Choose Direct air flow: the Twin-Sense cassette will target the corners with human activity.
- Choose Indirect air flow: Twin-Sense cassette will avoid the corners where occupants are detected.

Indirect air flow

Horizontal air flow, for circulation above and around occupants without air blowing directly on them.

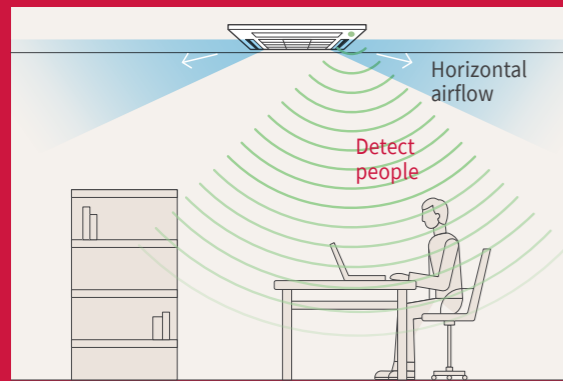

Ideal in places where occupants remain seated for a long time: restaurants, offices, theaters...

Direct air flow

Auto swing of louvers ensures that every occupant can feel the air blowing.

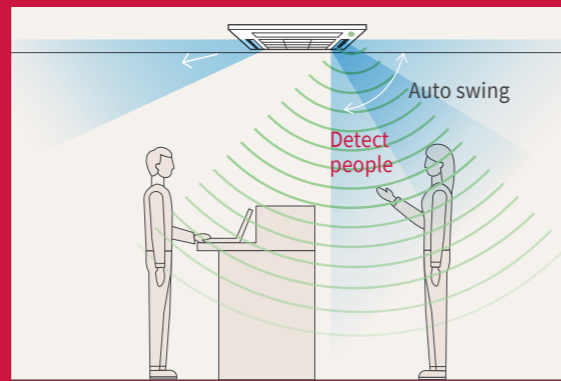

Ideal in places where occupants need to quickly warm up or cool down: entrance areas and corridors, hotel lobby...

Notes:

When room vacancy is detected, the air is directed in the way the controller (PC-ARFG) is set up. (Note) 4-zone motion sensor may not be effective in the following cases:

- If the room is occupied but the movement is minimal, the system might consider the room as vacant.
- If an object with a temperature different to the surrounding is in motion, it might be considered as human presence.

Occupancy sensing technology

With **CrowdSense** technology, select units can determine how many people are in a space and adjust the cooling or heating capacity accordingly, so the room will never get too hot or cold, whether it's crowded or almost empty.

- Hitachi Twin-Sense cassette detects the crowd's arrival or departure.
- Using AI, the cassette can anticipate the addition or reduction of human heat sources and immediately adjusts the air conditioning accordingly.

Requires optional motion sensor kit available for many Cassette and Ceiling Suspended models

Crowd-Sense action during cooling.

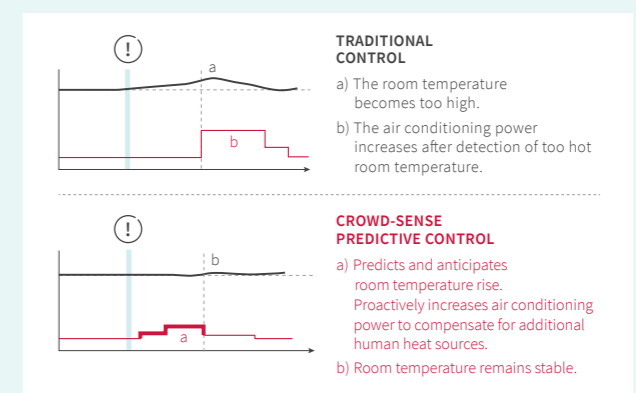
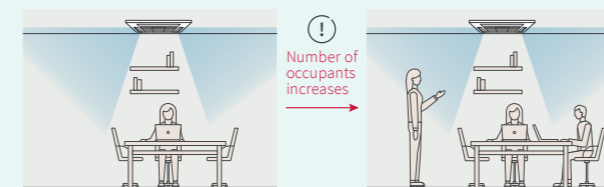

Crowd-Sense action during heating.

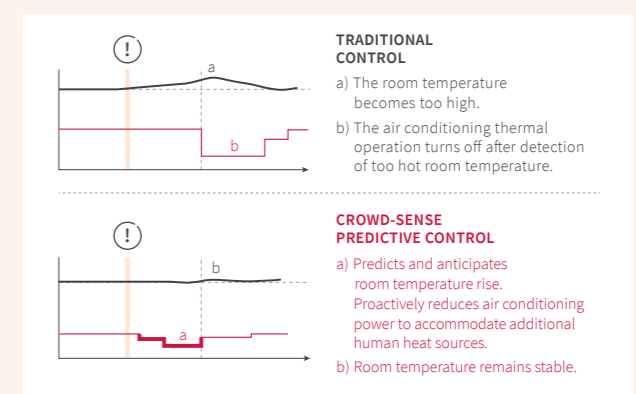
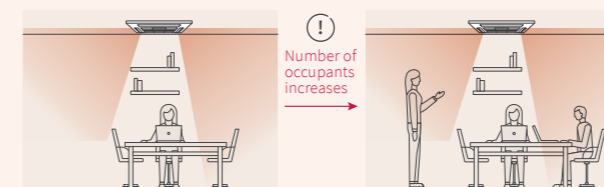

----- Target set temperature — Power — Room temperature — Time

Crowd-Sense may not be effective or might be less effective in the following cases:

- Multiple indoor units are in operation in the same zone.
- The difference between the radiant temperature of the room (floor and walls) and the radiant temperature of the human body is minimal.
- The room temperature is high before operation.
- During the heating process, when the number of occupants decreases.

Indoor units

CASSETTE | HUMAN SENSOR PANEL (OPTIONAL)

No more cold feet

In cooling scenarios, **FloorSense Cool**^{*1} can prevent the floor area from overcooling by controlling airflow and cooling capacity so that the air at floor level does not get as cool as air above knee height.

*1 Available on select Cassette models. Requires optional cassette panel with Motion Sensor & Radiant Temperature Sensor.

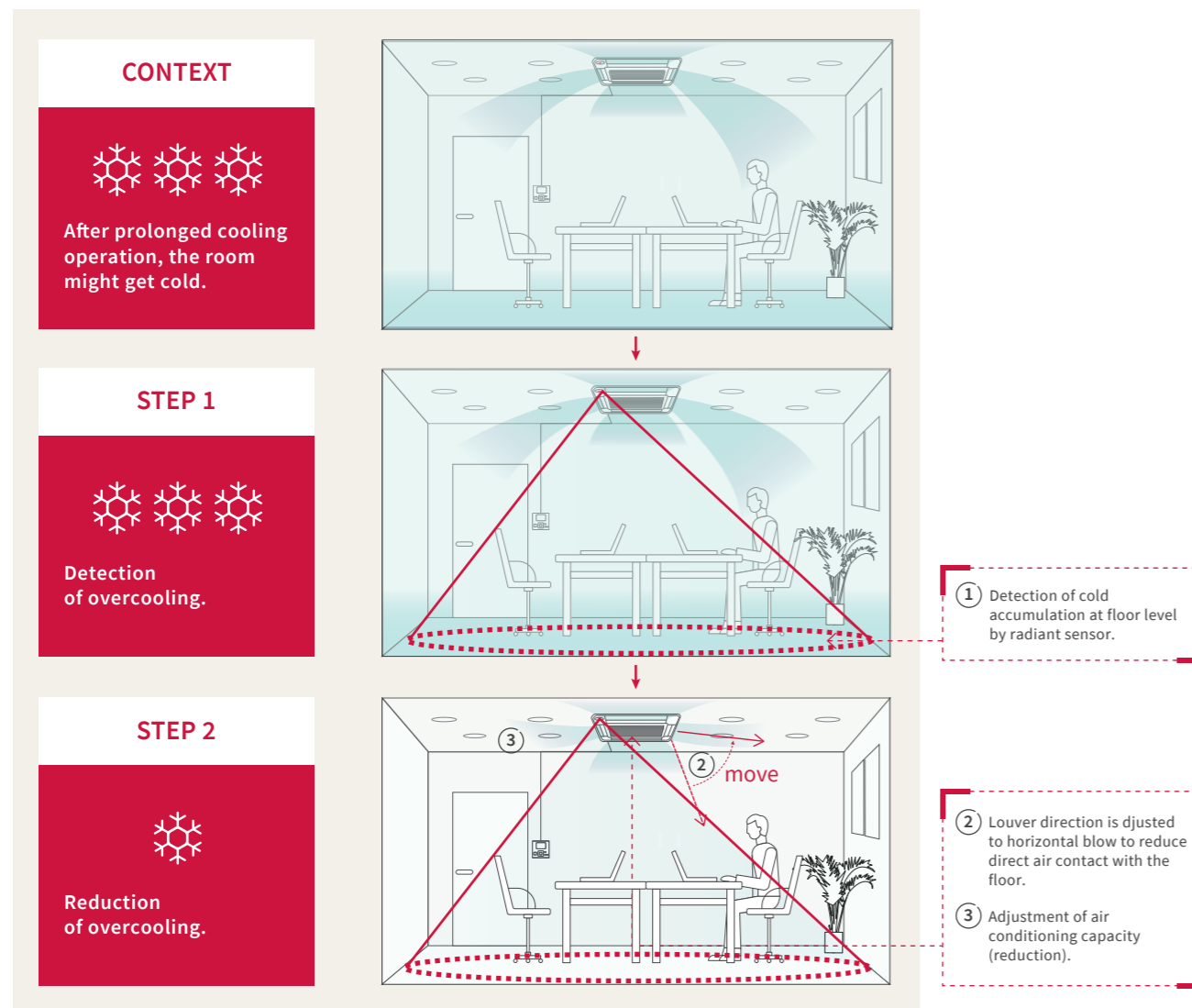

Compact Design

With a unit height of 238~288mm, easy for installation in tight clearance spaces.

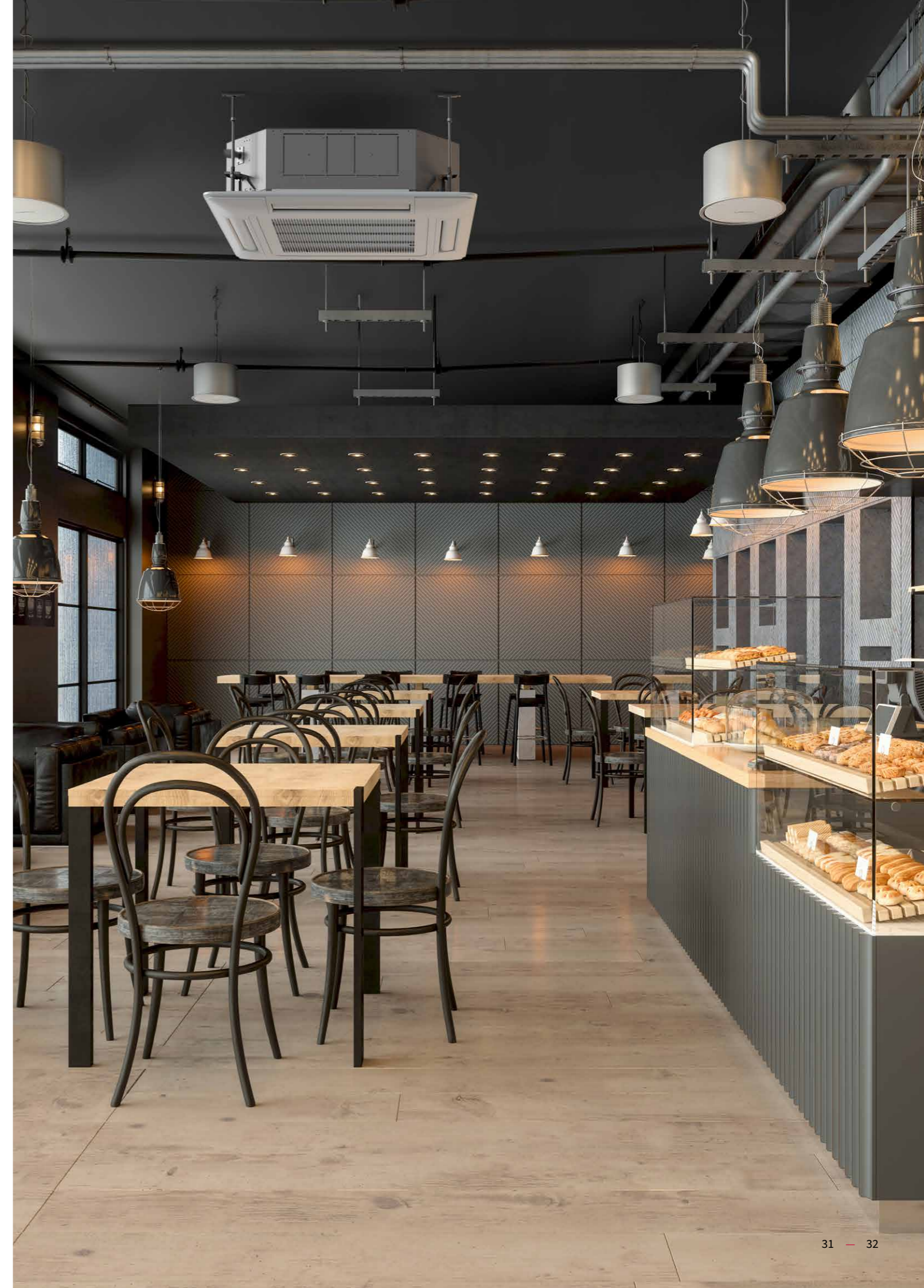

Indoor units

CASSETTE | HUMAN SENSOR PANEL (OPTIONAL)

FeetWarm (for heating operation) - head to toe comfort during winter

In room heating scenarios, it's common to hear users complain of cold feet because heat naturally rises. **FeetWarm** helps to solve this problem by optimizing airflow in heating mode to ensure that the leg zone is consistently heated.

Available on select Cassette models. Requires optional cassette panel with Motion Sensor & Radiant Temperature Sensor.

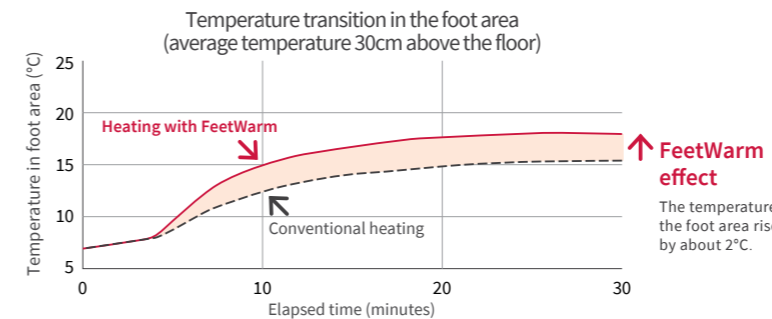

FeetWarm's boasts 4 intelligent features:

- Thanks to the Twin-Sense radiant sensor, it can detect heat stratification effects inside the room, which usually cause the floor and lower levels to be cooler.
- A 2-step action to first create consistent warmth, then to maintain it.
- Advanced heat air flow optimization, by sophisticated control of the 4-way cassette's individual louvers.
- The lower levels of the room (floor level, feet level, leg level) reach desired temperatures, for total comfort.

How does it work?

Step 1.

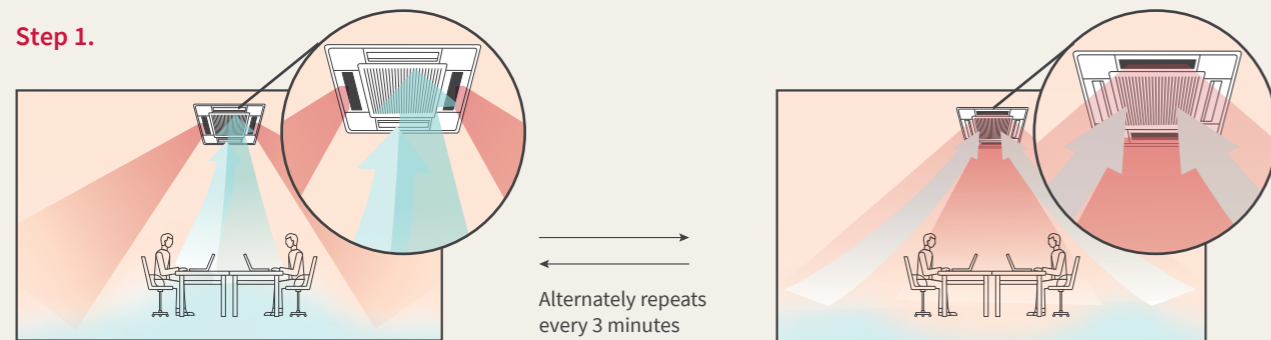

- ① The radiant sensor detects a temperature drop in the floor and around your feet.
- ② The cassette partially closes two louvers automatically.
- ③ The air flow strengthens through the two remaining open louvres, and targets the floor to warm it up quickly*1.
- ④ Louvre opening alternate every three minutes from wide open to partially closed to cover a wider floor area.
- ⑤ As louvre openings close, suction increases in the central inlet grill for a faster warming effect.

*1 Caution: when the indoor unit changes to heating, the sudden change in air flow might cause occupants to feel a cold draft sensation.

Effect of FeetWarm - Step 1.

Temperature distribution around the area of the feet (30min after air conditioning heating operation starts).

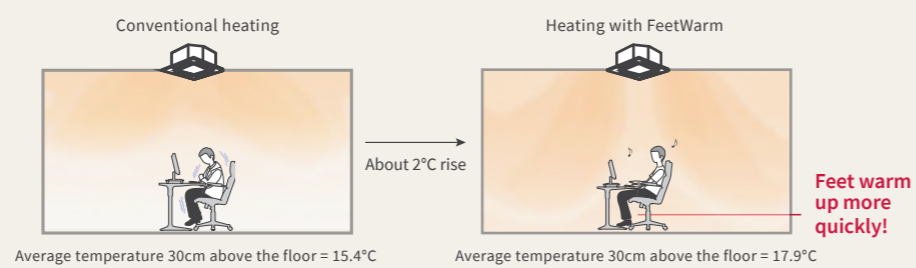

[Image based on calculation results]

Step 2.

- ① When the radiant temperature sensor detects that the lower level is no longer cold, FeetWarm shifts to its second step for a more even temperature everywhere in the room.
- ② One louver remains closed.
- ③ Three remaining open louvres follow Auto-Swing air flow direction, continuously moving up/down. This leads to faster circulation of the warm air in all areas of the room.
- ④ Suction of colder air remains facilitated thanks to the one partially closed louver.

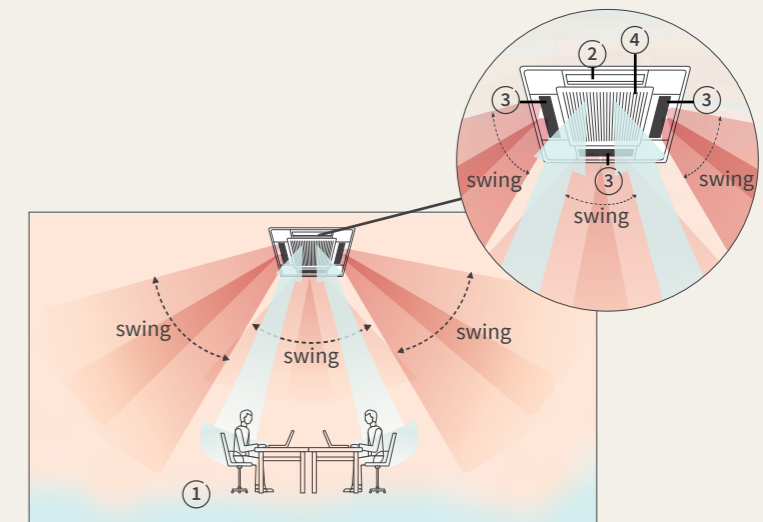

Effect of FeetWarm - Step 2.

Temperature distribution around the area of the feet (30min after air conditioning heating operation starts).

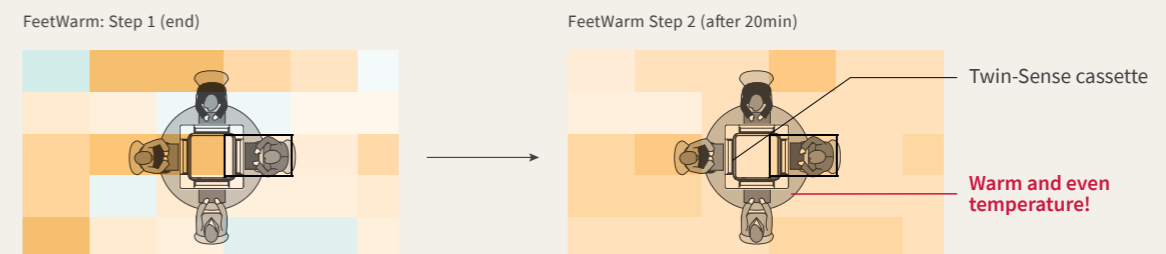

[Measurement condition Based on Hitachi research].

See simulation result under the following conditions above. Unit capacity: 8.0KW, room size: "height 3.2m, length 6.3m, width 6.3m", indoor initial temperature: 7°C, outdoor temperature: 7°C, indoor airflow temperature: 30°C for 0-5 minutes, Gradually rise from 30°C to 40°C after 5 minutes, Multi-function remote control setting: Airflow heat control "effective / long".
(Note) The effect varies depending on the size of the room and the load.



Indoor units

CEILING SUSPENDED

Lineup



5.0kW, 6.0kW

PPFC-2.0UFA1NQ
PPFC-2.5UFA1NQ



7.2kW, 10.0kW, 12.5kW, 14.0kW

PPFC-3.0UFA1NQ
PPFC-4.0UFA1NQ
PPFC-5.0UFA1NQ
PPFC-6.0UFA1NQ

Motion Sensor (Optional)

The ceiling suspended indoor unit is designed to be compatible with an optional motion sensor device. With a sensor distance of up to **7m**, this unit can detect occupancy in the room and automatically control the AC, turning it on or off accordingly. By avoiding unnecessary operation when the room is unoccupied, this feature contributes to energy conservation and helps reduce electric bills.

- ① 7m reach motion sensor (option: SOR-NEP).
Use a motion sensor for extra savings when the room is vacant.

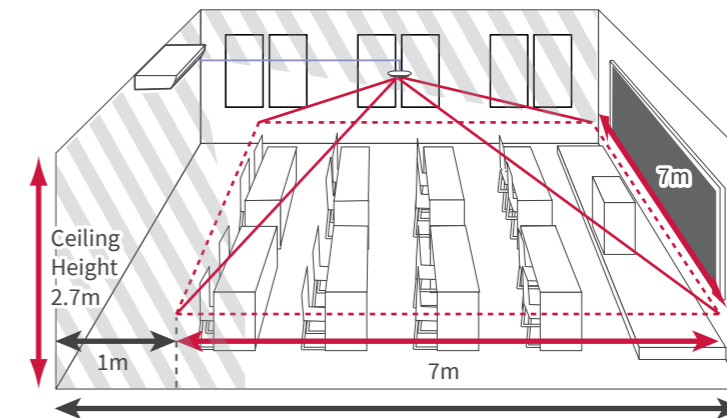

Auto-swing

The ceiling suspended unit offers an auto-swing function. The louvres are capable of horizontal auto-swing, allowing them to move from side to side or be set to a stationary position. This feature ensures that the cooling flow is evenly distributed to every corner of the room, providing exceptional comfort without any worries.

- ② Auto-swing available.

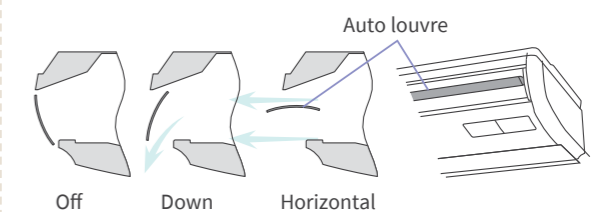

Controllers & Apps

37 | Controllers

- 38 | Wired Remote Controller (WRC)
- 39 | Hand-held Remote Control (HHRC)
- 40 | IR Receiver

41 | Apps

- 42 | airCloud Go
- 43 | airCloud Pro
- 44 | airCloud Tap
- 45 | Unit Compatible & Adapters

46 | Integrate with BMS

47 | H-LINK Integration

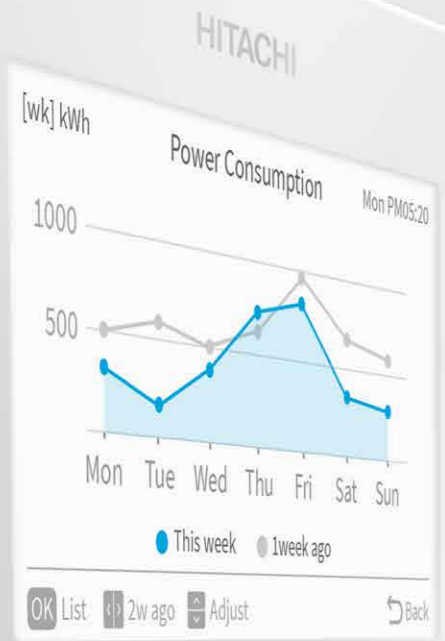

Controllers & Apps

INDIVIDUAL CONTROLLERS | WRC

airPoint Room 700 (PC-ARFG2-Z)



A new generation of room controllers with user friendly UX/UI

- Colourful screen
- Award winning design
- Visual interface
- Simplified navigation
- Access to latest Hitachi features
- Optimised for installers too
- Special functions for Hotels

Backup System Setting

- Rotation Operation
- Backup operation when abnormality occurs
- Backup operation in high load
- Settings on the controller is quite simple

ESP Setting

- Manually and automatic static pressure setting are supported, together with the traditional method of selecting from "Standard", "Hi Speed1", "Hi Speed2".



reddot winner 2021



Model	PC-ARFG2-Z
Product Name	airPoint Room 700
Dimension(mm)	W 120 × H 120* × D 16.5(thinnest part) W 120× H 120* × D 21.5(thickest part)
Weight	180g (Approx.)
Installation Method	Installed on the wall or switch box
Power supply	DC power supply from indoor Unit
Temperature Condition	0~40°C(40-104°F)
Humidity Condition	35~90% (non-condensation)
Embedded NFC	Yes

Functions

Function menu	Service and installation menu / Service	Service and installation menu / Check
Simple Timer	Lock Function	Setting Initialization
Operation Schedule	Password Setting	Main Controller Setting
Power Saving Setting	Hotel mode	Priority Setting
Night Quiet Operation	Power Saving Detail Setting	Cancel Preheating Control
Power Saving/Night Quiet Schedule	Temperature Range Restriction	Elevating Grille Setting
Power Consumption Display	Dual Setpoint	Power Up Setting
Autoboost	Main/Sub Display	Setback Trigger Unit
Comfort Setting	Set Room Name	Check 1
Motion Sensor Setting	Set Contact Information	Check 2
Setback Setting	NFC Setting	Alarm History Display
Elevating Grille	Simple Maintenance	Display Model Number
Reset Filter Reminder Time	Backup System Setting	Check PCB of the Units
FrostWash Setting	ESP Setting	Self Check
Individual Louver Setting	Test Run	Common Zone Setup
Louver Open/Close	Function Selection	Zone Activation
Adjust Date/Time	Input/Output	Zone Labeling
Run Indicator Brightness	Thermistor Selection	Zone Labeling
Display Adjustment	Thermistor Calibration	Nominate Spill Zone(s)
Temperature	Fan Speed Thermo-Off	Sensor Assignment
Language Setting	Indoor Unit Address Change	Airflow
Chinese (Simplified/Traditional), Japanese, English(°C/°F), French, Portuguese, Spanish	Address Check Operation	Minimum Airflow Ratio
Keypad Touch Sound	Address Initialization	Damper Timing
		Turn On All Zones

*Individual Controller Functions are available depending on the airCore 700 indoor unit connected (Cassette / Ceiling Suspended / Ducted / Ducted with Premium Zone Control Kit).

Controllers & Apps

INDIVIDUAL CONTROLLERS | HHRC

PC-LH8QE

Dimensions: 180x48x22.15 mm
Weight: 0.156 kg

Powerful, innovative & compact

- Designed to embody a fresh and innovative appearance
- Modular concept and seamlessly integrated across the entire region
- Featuring an intuitive design and a cutting-edge segment display
- Featuring a larger LCD measuring 31x50 mm with backlight.
- Covering both basic and advanced features, including Run/Stop, Up/Down, Left/Right, Louver settings, Cooling/Heating, Dry, and Timer.



INDIVIDUAL CONTROLLERS | IR RECEIVER

Simultaneous Control of Multiple Units

One IR Receiver Kit can be used to control simultaneously a number of indoor units (up to 16 devices). When a number of indoor devices are installed in a large room, one single wireless remote controller can be used to run and stop all these devices.



NOTE:

When a number of units are under simultaneous control, all their indoor devices shall be placed in the same room. If using one wireless remote controller to control air conditioners in more than two rooms, it is possible to forget to close one.

PC-ALHZ5Q, PC-ALH5Q

Model	PC-ALHZ5Q	PC-ALH5Q
Dimension(mm)	120*90*28mm	203*203*35.8mm
Weight	255g(Approx.)	188g(Approx.)
Product Name	Wireless Receiver Kit	
Installation Method	Installed on the wall or switch box	Installed on IDU panel
Power supply	DC power supply from indoor unit	
Max. Distance	RC-Link, 300m	
Max. number of connected indoor	16	
Temperature Condition	0~40°C(40~104°F)	
Humidity Condition	35~90% (non-condensation)	

- GVBL Decoration Film
- Powerful
 - To raise or lower the temperature immediately in cooling & heating mode
- Sleep
 - A more comfortable environment for sleep
 - Sleep time is fixed as 8 hours
- Auto FrostWash Enable/Disable



Compatible IDU models

Indoor Unit Type	Model Name	IR receiver
4-Way Cassette	PCI-2.0UFA1NQ	PC-ALH5Q
	PCI-2.5UFA1NQ	
	PCI-3.0UFA1NQ	
	PCI-4.0UFA1NQ	
	PCI-5.0UFA1NQ	
	PCI-6.0UFA1NQ	
Ducted	PPIM-2.0UFA1NQ	PC-ALHZ5Q
	PPIM-2.5UFA1NQ	
	PPIM-3.0UFA1NQ	
	PPIM-4.0UFA1NQ	
	PPIM-5.0UFA1NQ	
	PPIM-6.0UFA1NQ	
Mini Cassette	PCIM-B09UFA1DQ	PC-ALHC5Q
	PCIM-B12UFA1DQ	

Limitation: when IR receiver works as Primary/secondary controller, it will disable backup system setting & ESP setting

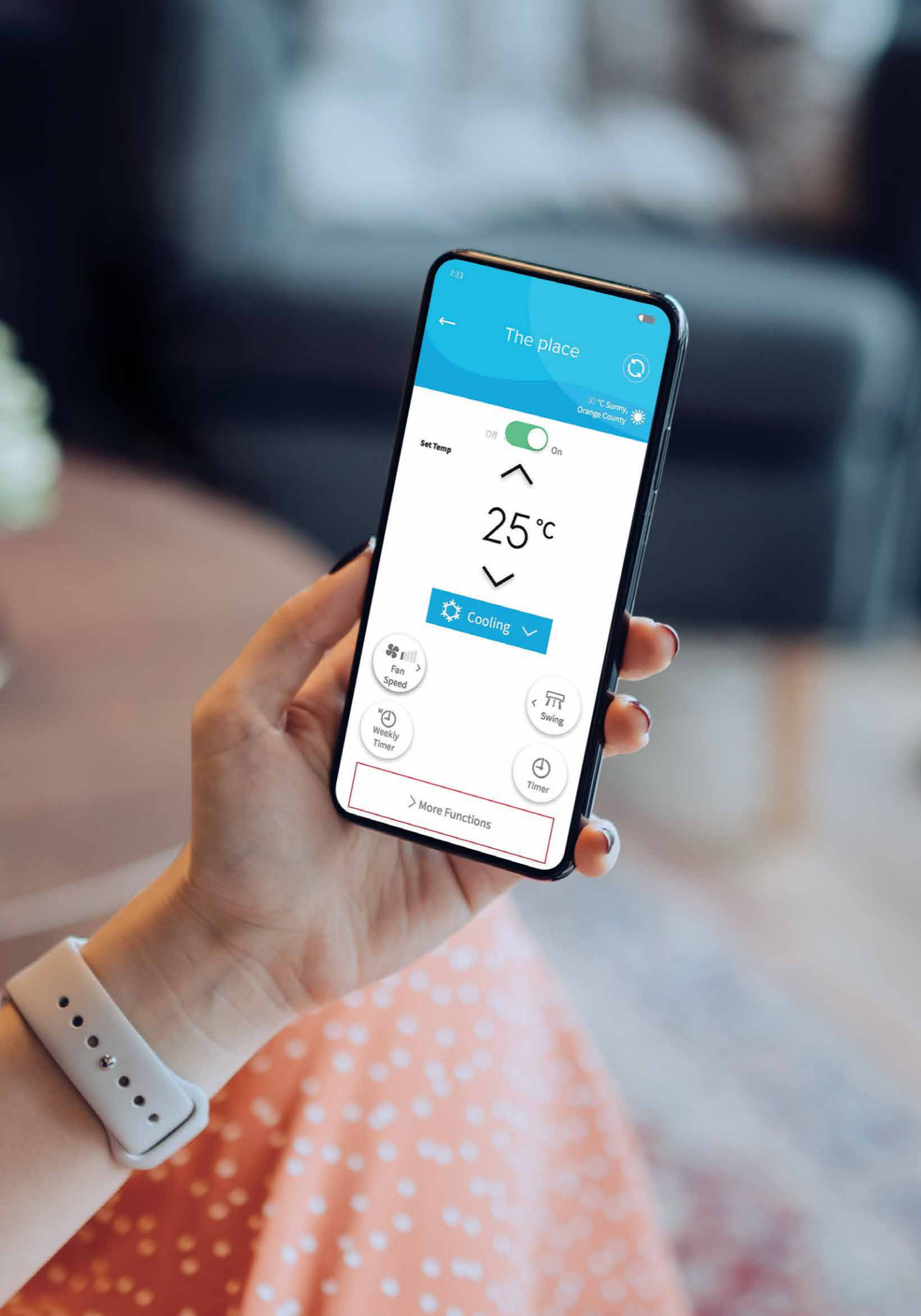

Controllers & Apps

APPS | airCloud Go*

Remotely control individual indoor units or premium zoning systems.



airCloud Go

Connect your Hitachi air conditioners to airCloud Go via wifi.



Voice control

Connect with your smart speaker and set your indoor climate via voice control.



Amazon Echo



Google Home

Turn the air conditioner on/off and set the desired temperature, fan speed and airflow direction.

Program your air conditioning operation with the Simple Timer and/or Weekly Timer.

Pair your account with unlimited air conditioners.

Invite up to 20 users to manage each air conditioner.



App available in 21 languages

English, French, Italian, Spanish, German, Portuguese (BR & EU), Dutch, Danish, Swedish, Thai, Chinese (Traditional & Simplified), Indonesia, Polish, Hungarian, Czech, Romanian, Greek, Croatian, Slovenian, Vietnamese, Malay

airCloud Adapter (GA-WFG)

Introducing the new airCloud Adapter, compatible with the airCloud Go App, enabling remote control of airCore 700 Ducted, Cassette and Ceiling Suspended systems.



Quick set up

QR code recognition enables you to pair your app to your air conditioner in an instant.



Control your AC from anywhere!

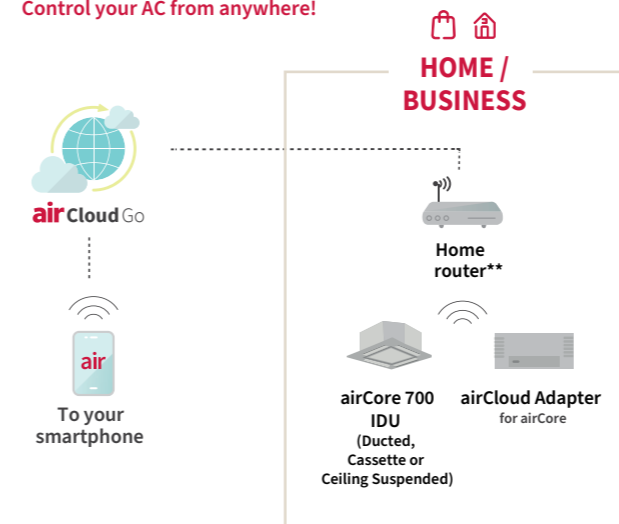

*airCloud Go SmartFence & energy monitoring not available with airCore 700

Controllers & Apps

APPS | airCloud Pro

Your **airCore700** could be controlled by airCloud Pro NOW.



airCloud Pro
24/7 control at your fingertips
on smartphone app or web

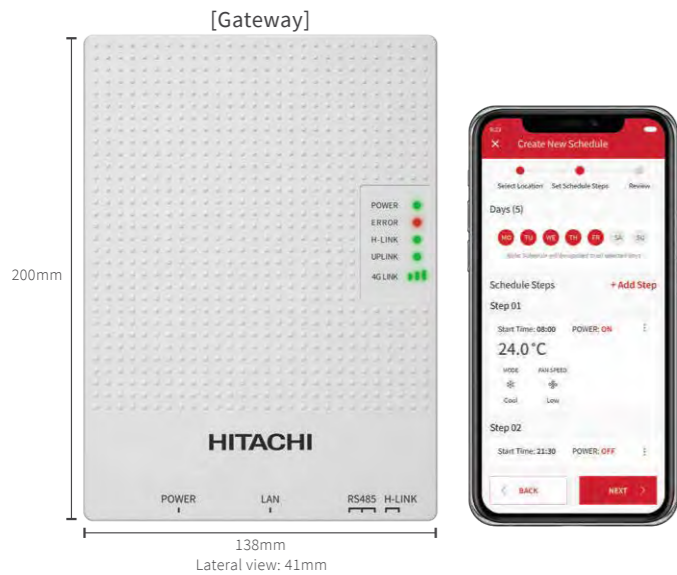

iIoT Solution:
Cloud-Based Control System with Dedicated App

A simple yet powerful tool.

✓ Intuitive simplicity

airCloud Pro is designed to make your job easier. An intuitive app that anyone can use, airCloud Pro makes managing your AC systems easier than ever before.

✓ Control from anywhere

Enjoy the freedom of remote access from your smartphone, tablet or laptop. airCloud Pro allows you to remotely control your AC system(s) from a single app, saving you travel time.

Functions:

- Basic control commands for Indoor Units: ON/OFF, mode, fan speed, temperature setting, RCS lock.
- Simple weekly timer.
- Alarm information on unit list.
- General dashboard per installation, system summary, and global ON/OFF order to all IDUs.
- Management of several sites/gateways/users with dedicated views.
- Internet connection is mandatory for airCloud Pro: This is a cloud-based product.
- Ideal for customers managing multiple sites.
- Multiple users can be created with simultaneous connection to the installation.

Specifications

Gateway Specs	IDU Per gateway	80 IDUs
	ODU Per gateway	16
	Device per H-LINK	1
Cloud Access		Yes
Web App		Yes
Mobile App		Yes
Connectivity	Primary Connectivity	Ethernet
	4G Connectivity	Optional
Access to System	Local Access	Yes (Backup with limited features)
	Remote Access	Yes
	Server Type	Cloud
	Mandatory Internet Connection	Yes
User & Site Management		Yes
Installation Dashboard		Yes
App Languages		Supports multiple languages

System configuration

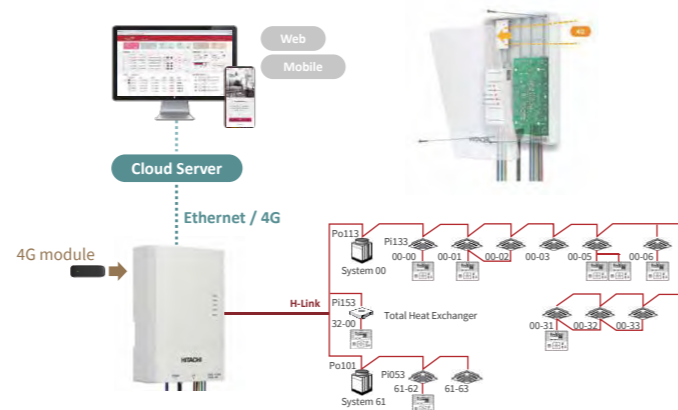

visit discover-aircloud.hitachiircon.com

APPS | airCloud Tap

Convenient tools for quick installation and service.



airCloud Tap (NFC)
for using with PC-ARFG2-Z

Improved serviceability with airCloud Tap

“airCloud Tap” is used setting the controller from smartphone easily.

(NFC feature on PC-ARFG2-Z is disabled when connected with Zone interface box.)

To download the “airCloud Tap” application, search for it on the “App Store”^{*1} or “Google Play”^{*2}. Alternatively, you can scan the code provided below with your smartphone to directly access the application.



*1 App Store® is a service mark of Apple Inc.
*2 Google Play and the Google Play logo are trademarks of Google LLC.



Read & Write settings with your phone 4 steps:

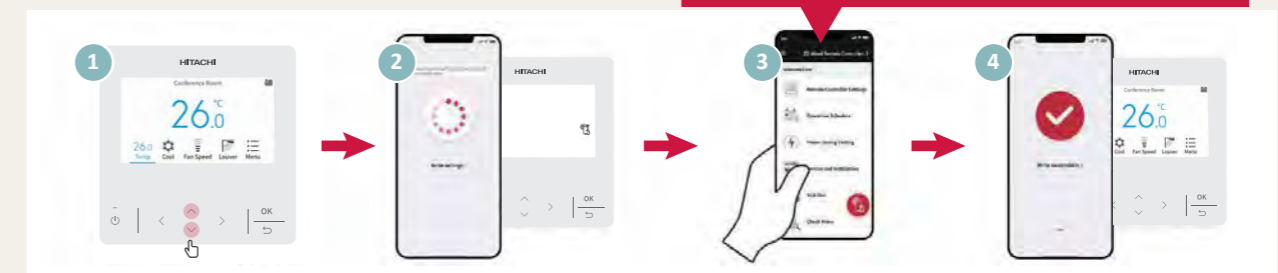

Activate the NFC function on the controller.

Open the airCloud Tap app and tap the controller with your phone to read the settings.

Edit the desired settings on your phone via airCloud Tap app.

Tap the controller again with your phone to write the new settings and apply them to the controller.

Less button to press

- No need to stay close to the controller during editing
- Easier to edit on the phone rather than controller
- More complete descriptions of functionalities

Controllers & Apps

APPS | UNIT COMPATIBLE

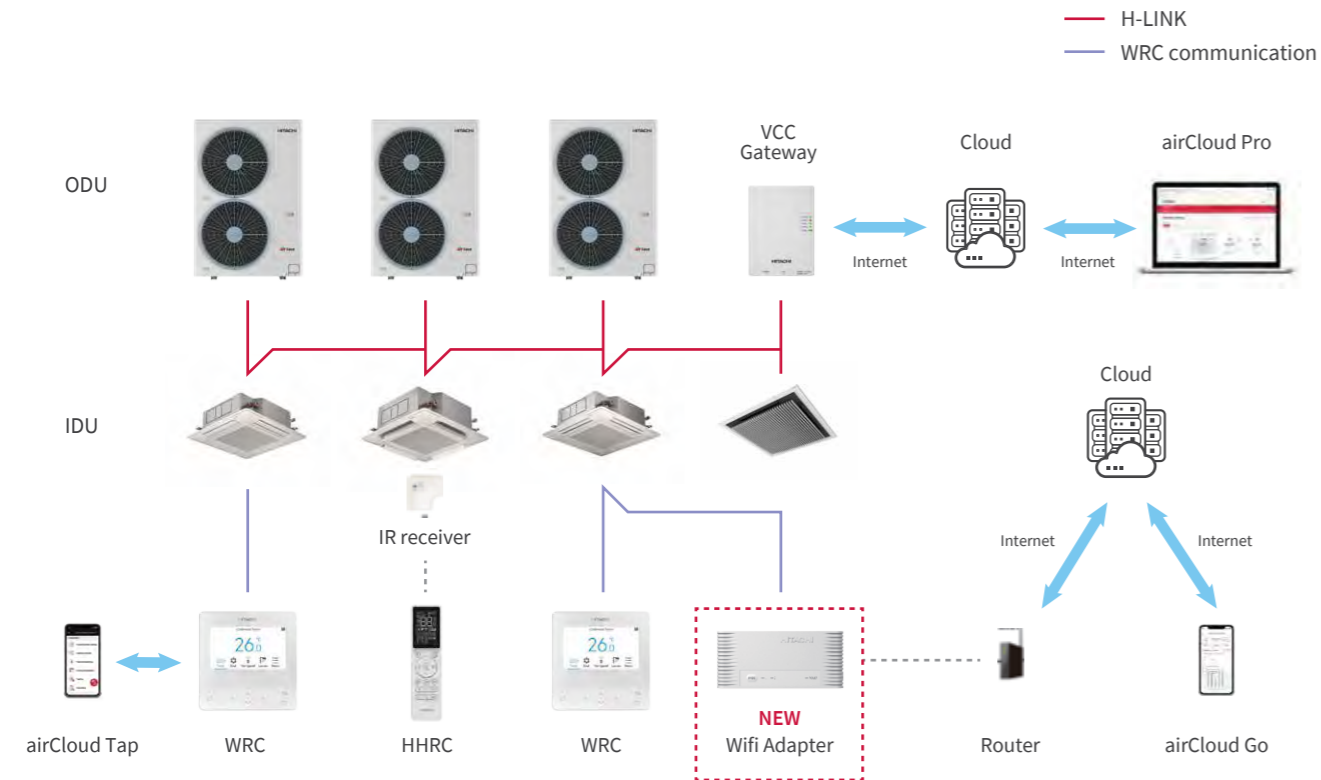

Wifi Adapter

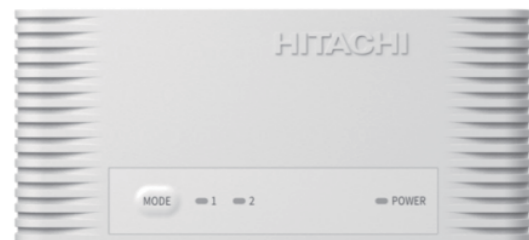

- ABS plastic housing.
- Configuration: AP and WPS.
- Operating temperature: 5°C to 35°C.
- Operating humidity: between 35% and 90%.
- Index protection rating IP30.
- Pollution category: Class 2.
- Dimensions (l x w x h): 105 x 46 x 20 mm.
- Wireless LAN standard: IEEE 802.11b/g/n.
- Security: WPA/WPA2.
- Frequency used and maximum power used: 2.4000 GHz - 2.4835 GHz/erp < 100 mW.
- Power supply: 15V 110mA DC
- Integrated antenna.

Compatible IDU models

Indoor Unit Type	Model Name	IR receiver
Cassette	PCI-2.0UFA1NQ	PC-ALH5Q
	PCI-2.5UFA1NQ	
	PCI-3.0UFA1NQ	
	PCI-4.0UFA1NQ	
	PCI-5.0UFA1NQ	
	PCI-6.0UFA1NQ	
	PCI-6.5UFA1NQ	
Ceiling Suspended	PPFC-2.0UFA1NQ	(Built-in IR)
	PPFC-2.5UFA1NQ	
	PPFC-3.0UFA1NQ	
	PPFC-4.0UFA1NQ	
	PPFC-5.0UFA1NQ	
	PPFC-6.0UFA1NQ	
MSP Ducted	PPIIM-2.0UFA1NQ	PC-ALHZ5Q
	PPIIM-2.5UFA1NQ	
	PPIIM-3.0UFA1NQ	
	PPIIM-4.0UFA1NQ	
	PPIIM-5.0UFA1NQ	
	PPIIM-6.0UFA1NQ	
HSP Ducted	PPIH-3.0UFA1NQ	PC-ALHZ5Q
	PPIH-4.0UFA1NQ	
	PPIH-5.0UFA1NQ	
	PPIH-6.0UFA1NQ	
	PPIH-6.5UFA1NQ	

CONNECT TO BMS



BMS ADAPTER for BACnet®

HC-A64BNP1
CONTROL UP TO 64 INDOOR UNITS

General Functions

- Run / Stop
- Operation Mode
- Temperature Setting / Status
- Fan Speed
- Filter Sign / Reset
- Prohibited / Permitted RC Operation
- Indoor Air Intake Temperature (IDU Inlet Temp)
- Communication State
- Alarm Signal
- Alarm Code

Hardware Specifications

Upper-level communication (BMS Side / BMS Protocol)	BACnet IP Control
Lower-level communication (AC side)	H-Link II
Central Controller used together with the same H-Link	Up to 4 units can be used in combination with BACnet adapter (CC: PSC-A16RS, PSC-A64S, PSC-A64GT)
Dimensions (H x W x D)	68mm x 204mm x 154mm
Weight	1.4kg
Power	AC 220-240V 50/60Hz

Note: Two BACnet adapters cannot be used together.
Note: BACnet adapter cannot be used with Central Controller EX.



BMS ADAPTER for LonWork®

HC-A64LNP
CONTROL UP TO 64 / 32 / 16 RCG (Remote Control Group)

HC-A64LNP offers various control/monitor modes:

- Standard (64 RCG)
- Option A (64 RCG)
- Option B (32 RCG)
- Option C (16 RCG)

Each mode has different control/monitor points and RCG configurations.

General Functions

- Run / Stop
- Operation Mode
- Temperature Setting / Status
- Fan Speed
- Louver Setting
- Prohibited / Permitted RC Operation
- Filter Sign / Reset
- Alarm Code
- Thermo Status

Hardware Specifications

Upper-level communication (BMS Side / BMS Protocol)	LonTalk
Lower-level communication (AC side)	H-Link II
Central Controller used together with the same H-Link	EZ, Mini (Either EZ or Mini)
Number of adapters used together with the same H-Link	Standard - 1 Option A - 1 Option B - 2 Option C - 4
Dimensions (H x W x D)	** 92mm x 110mm x 124mm
Weight	670g
Power	AC 220-240V 50/60Hz

Note: LonWork adapter can not be used with Central Controller EX.

Controllers & Apps

H-LINK INTEGRATION

Enjoy more freedom

What is H-LINK?

H-LINK is Hitachi Cooling & Heating's unique communication system for centralised control of VRF (Variable Refrigerant Flow) systems. Now, the airCore700, a large single split system, can connect directly to a Hitachi VRF system, enabling centralised controls.

H-LINK simplifies commissioning and service maintenance for installers and service engineers. It also offers remarkable versatility to building owners and occupants by enabling various central control options, resulting in improved system management.

Our advanced communication system streamlines the connection of control wiring between indoor and outdoor units, while also empowering a central control system to manage indoor/outdoor units across multiple refrigerant systems.

Examples



Educational institutions such as primary schools where installation work cannot be performed on weekdays.



Hotels where it is preferable to complete installation work during late evenings.



Rehabilitation facilities or hospitals where it is necessary to minimize the burden on users.

3x
more
benefits!

1

Flexible wiring routes:
no restrictions & time-saving at installation.

2

Can connect with various types of Hitachi air conditioning products, including VRF mini splits and airCore700, for centralised controls.

3

No adapter is needed!
Simple connection to terminal blocks for centralised controls.

Centralized Controls: Flexible Wiring Route!

- ① • Multiple refrigerant systems located in one area.
- Central monitoring room in separate area.

H-LINK SOLUTION

- Wire the central station to the closest indoor unit.
- Wiring distance is reduced substantially.
- Single split system (airCore700) could integrate with VRF system and connect to centralised controls seamlessly without an adapter.

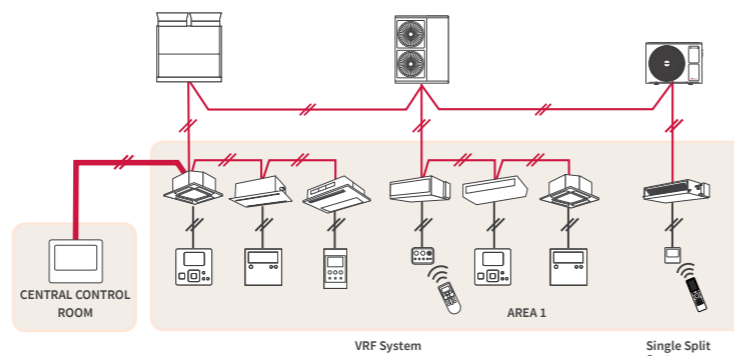

- ② • One single split system is located in another separate area.

H-LINK SOLUTION

- Connect the farthest refrigerant system directly to central station either to outdoor units or indoor units.
- The central station can make the central link between the different refrigerant systems.

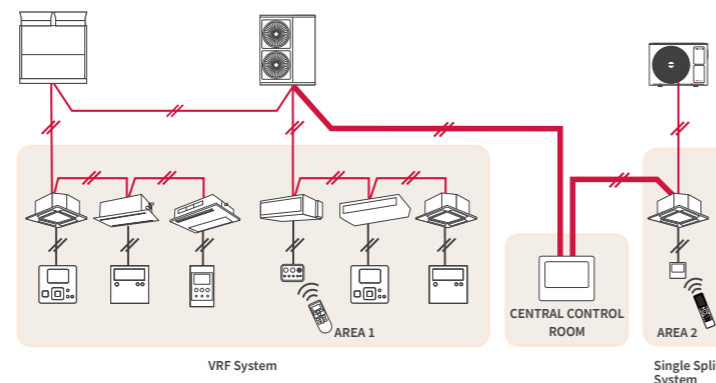

Specifications

MSP DUCTED

IDU		PPIM-2.0UFA1NQ	PPIM-2.5UFA1NQ	PPIM-3.0UFA1NQ	PPIM-4.0UFA1NQ	PPIM-4.0UFA1NQ	PPIM-5.0UFA1NQ	PPIM-5.0UFA1NQ	PPIM-6.0UFA1NQ	PPIM-6.0UFA1NQ	
ODU		PAS-2.0UFASNQ1	PAS-2.5UFASNQ1	PAS-3.0UFASNQ1	PAS-4.0UFASNQ1	PAS-4.0UFASMQ1	PAS-5.0UFASNQ1	PAS-5.0UFASMQ1	PAS-6.0UFASNQ1	PAS-6.0UFASMQ1	
Power supply (Indoor)	V/Ph/Hz	220-240~,50	220-240~,50	220-240~,50	220-240~,50	220-240~,50	220-240~,50	220-240~,50	220-240~,50	220-240~,50	
Power supply (Outdoor)	V/Ph/Hz	220-240~,50	220-240~,50	220-240~,50	220-240~,50	380-415 3N~,50	220-240~,50	380-415 3N~,50	220-240~,50	380-415 3N~,50	
Max. power input	kW	3.08	3.08	3.52	5.5	5.5	6.0	6.0	6.27	6.27	
Max. current input	A	14.0	14.0	16.0	25.0	12.0	27.3	12.0	28.5	12.0	
Cooling	Rated Capacity	kW	5.0	6.0	7.2	10.0	10.0	12.5	12.5	14.0	14.0
	Capacity Range[Min~Max]	kW	1.5~6.0	1.5~7.5	2.5~8.6	3.2~12.0	3.2~12.0	4.0~14.2	4.0~14.2	5.0~16.0	5.0~16.0
Heating	Rated Capacity	kW	6.0	7.5	8.6	11.5	11.5	14.0	14.0	16.0	16.0
	Capacity Range[Min~Max]	kW	1.5~7.5	1.5~9.0	3.5~10.4	3.5~14.0	3.5~14.0	4.0~16.2	4.0~16.2	5.5~18.0	5.5~18.0
Power consumption	Cooling	kW	1.28	1.58	1.97	2.67	2.67	3.52	3.52	4.18	4.18
	Heating	kW	1.46	2.05	2.09	2.88	2.88	3.59	3.59	4.32	4.32
EER	Cooling	kW/kW	3.90	3.80	3.65	3.75	3.75	3.55	3.55	3.35	3.35
COP	Heating	kW/kW	4.10	3.65	4.10	4.00	4.00	3.90	3.90	3.70	3.70
AEER	Cooling		3.80	3.70	3.60	3.65	3.65	3.50	3.50	3.30	3.30
ACOP	Heating		4.00	3.55	4.00	3.90	3.90	3.80	3.80	3.60	3.60
TCSPF(Cooling) Commercial /Residential	Hot		5.35/4.96	5.15/4.79	5.24/4.89	5.23/4.89	4.95/4.62	5.29/4.89	5.15/4.78	5.05/4.71	5.03/4.66
	Average		4.26/4.39	5.13/4.26	5.24/4.43	5.17/4.38	4.84/4.05	5.27/4.33	5.12/4.24	5.11/4.31	5.05/4.19
	Cold		4.26/4.41	5.42/4.30	5.54/4.50	5.43/4.40	5.06/4.02	5.57/4.39	5.41/4.28	5.44/4.43	5.35/4.27
HSPF(Heating) Commercial /Residential	Hot		2.73/3.01	2.81/3.06	3.23/3.49	2.96/3.22	2.56/2.85	2.73/3.01	2.73/3.02	3.19/3.41	2.84/3.08
	Average		3.05/3.66	3.59/3.46	3.94/3.75	3.72/3.49	3.58/3.47	3.70/3.60	3.73/3.64	3.77/3.61	3.59/3.46
	Cold		3.05/3.32	3.35/3.11	3.62/3.32	3.44/3.10	3.39/3.15	3.47/3.24	3.50/3.28	3.47/3.21	3.35/3.11
Indoor Unit	External Static Pressure-Range	Pa	35~185	35~185	35~185	50~200	50~200	60~210	60~210	60~215	60~215
	Fan Motor Output	W	250	250	250	375	375	375	375	375	375
	Air Flow[Hi2/Hi1/Hi/Med/Lo/SLo]	L/s	350/320/280/200/180/160	350/320/280/200/180/160	500/470/430/350/320/290	630/575/500/450/390/350	630/575/500/450/390/350	680/630/580/450/400/360	680/630/580/450/400/360	730/685/620/510/475/410	730/685/620/510/475/410
	Sound Pressure Level [Hi2/Hi1/Hi/Med/Lo/SLo]	dB[A]	39/36/34/30/24/21.5	39/36/34/30/24/21.5	38/36/34/31/26/24	41/39/36/34/30/27	41/39/36/34/30/27	43/40/38/36/30/28	43/40/38/36/30/28	45/44/40/38/35/32	45/44/40/38/35/32
	Sound Power Level	dB[A]	49	49	49	53	53	54	54	56	56
	Dimension [W×H×D]	mm	900(+75)×270×720	900(+75)×270×720	1100(+75)×300×800	1400(+75)×300×800	1400(+75)×300×800	1400(+75)×300×800	1400(+75)×300×800	1400(+75)×300×800	1400(+75)×300×800
	Supply Air Spigot [W×H]	mm	834x140	834x140	1038x197	1338x197	1338x197	1338x197	1338x197	1338x197	1338x197
	Return Air Spigot [W×H]	mm	857x227	857x227	1049x258	1350x258	1350x258	1350x258	1350x258	1350x258	1350x258
	Packing [W×H×D]	mm	1150×380×875	1150×380×875	1350×410×955	1650×410×955	1650×410×955	1650×410×955	1650×410×955	1650×410×955	1650×410×955
	Net/Gross Weight	kg	30/36	30/36	40/47	48/56	48/56	48/56	48/56	48/56	48/56
	Drainage water pipe diameter	mm	VP25	VP25	VP25	VP25	VP25	VP25	VP25	VP25	VP25
	Outdoor Unit	Compressor	Type	KTN150D42UFZD	KTN150D42UFZD	KTM240D43UKT	ATH356SKRC9EQ	ATH356SKRC9EQ	ATH356SKRC9EQ	ATH356SKRC9EQ	ATH356SKRC9EQ
		R.L.A	7.7	7.7	9.3	11.5	11.5	11.5	11.5	11.5	11.5
Fan Motor		F.L.A	0.34	0.34	0.34	0.62	0.62	0.62	0.62	0.62	0.62
Fan Motor Output		W	80	80	80	138	138	138	138	138	138
Air Flow		m³/h	3290	3290	3290	4800	4800	8200	8200	8200	8200
Sound Pressure Level-Cooling		dB[A]	53	53	53	56	56	56	56	56	56
Sound Pressure Level-Heating		dB[A]	54	54	54	57	57	57	57	57	57
Sound Pressure Level-Night		dB[A]	51	51	51	54	54	54	54	54	54
Sound Power Level		dB[A]	66	67	70	71	71	72	72	73	73
Throttle Type			Electronic Expansion Value	Electronic Expansion Value	Electronic Expansion Value	Electronic Expansion Value	Electronic Expansion Value	Electronic Expansion Value	Electronic Expansion Value	Electronic Expansion Value	Electronic Expansion Value
Dimension [W×H×D]		mm	900×665×320	900×665×320	900×665×320	950×990×320	950×990×320	950×1380×320	950×1380×320	950×1380×320	950×1380×320
Packing [W×H×D]		mm	1056×717×427	1056×717×427	1056×717×427	1070×1120×470	1070×1120×470	1070×1520×470	1070×1520×470	1070×1520×470	1070×1520×470
Net/Gross Weight	kg	42.0/45.5	42.0/45.5	44.0/48.0	86.5/100.5	86.5/100.5	98.5/109.0	98.5/109.0	108.0/118.5	108.0/118.5	
Refrigerant type /Quantity	Type		R32	R32	R32	R32	R32	R32	R32	R32	
	Charge	kg	1.2	1.2	1.4	3.0	3.0	3.1	3.1	3.4	3.4
	GWP		675	675	675	675	675	675	675	675	675
Design pressure	H/L	MPa	4.15/2.21	4.15/2.21	4.15/2.21	4.15/2.21	4.15/2.21	4.15/2.21	4.15/2.21	4.15/2.21	
Refrigerant pipe	Liquid side/Gas side	mm	Φ6.35/Φ12.7	Φ6.35/Φ12.7	Φ6.35/Φ12.7	Φ9.52/Φ15.88	Φ9.52/Φ15.88	Φ9.52/Φ15.88	Φ9.52/Φ15.88	Φ9.52/Φ15.88	
	Max. pipe length	m	50	50	75	75	75	75	75	75	
	Max. Height difference	m	30	30	30	30	30	30	30	30	
	Add Refrigerant Amount	g/m	18	18	18	35	35	35	35	35	
	Chargeless	m	30	30	30	30	30	30	30	30	
Guaranteed Temperature Operation Range	Cooling	°C	-5~52	-5~52	-5~52	-5~52	-5~52	-5~52	-5~52	-5~52	
	Heating	°C	-15~15.5	-15~15.5	-15~15.5	-15~15.5	-15~15.5	-15~15.5	-15~15.5	-15~15.5	

Specifications

HSP DUCTED

IDU		PPIH-3.0UFA1NQ	PPIH-4.0UFA1NQ	PPIH-4.0UFA1NQ	PPIH-5.0UFA1NQ	PPIH-5.0UFA1NQ	PPIH-6.0UFA1NQ	PPIH-6.0UFA1NQ	PPIH-6.5UFA1NQ	PPIH-6.5UFA1NQ	
ODU		PAS-3.0UFASNQ1	PAS-4.0UFASNQ1	PAS-4.0UFASMQ1	PAS-5.0UFASNQ1	PAS-5.0UFASMQ1	PAS-6.0UFASNQ1	PAS-6.0UFASMQ1	PAS-6.5UFASNQ1	PAS-6.5UFASMQ1	
Power supply (Indoor)	V/Ph/Hz	220-240~,50	220-240~,50	220-240~,50	220-240~,50	220-240~,50	220-240~,50	220-240~,50	220-240~,50	220-240~,50	
Power supply (Outdoor)	V/Ph/Hz	220-240~,50	220-240~,50	380-415,3N~,50	220-240~,50	380-415 3N~,50	220-240~,50	380-415 3N~,50	220-240~,50	380-415 3N~,50	
Max. power input	kW	3.52	5.5	5.5	6.0	6.0	6.27	6.27	6.27	6.27	
Max. current input	A	16.0	25.0	12.0	27.3	12.0	28.5	12.0	28.5	12.0	
Cooling	Rated Capacity	kW	7.2	10.0	10.0	12.5	12.5	14.0	14.0	16.0	
	Capacity Range[Min~Max]	kW	2.5~8.6	3.2~12.0	3.2~12.0	4.0~14.2	4.0~14.2	5.0~16.0	5.0~16.0	6.0~18.0	
Heating	Rated Capacity	kW	8.6	11.5	11.5	14.0	14.0	16.0	16.0	18.0	
	Capacity Range[Min~Max]	kW	3.5~10.4	3.5~14.0	3.5~14.0	4.0~16.2	4.0~16.2	5.5~18.0	5.5~18.0	6.5~20.0	
Power consumption	Cooling	kW	2.06	2.75	2.75	3.41	3.41	3.99	3.99	5.06	
	Heating	kW	2.18	3.35	3.35	3.35	3.35	4.16	4.16	4.88	
EER	Cooling	kW/kW	3.50	3.63	3.63	3.67	3.67	3.51	3.51	3.16	
COP	Heating	kW/kW	3.95	3.73	3.73	4.18	4.18	3.97	3.97	3.69	
AEER	Cooling		3.50	3.56	3.56	3.60	3.60	3.47	3.47	3.13	
ACOP	Heating		3.90	3.70	3.70	4.10	4.10	3.90	3.90	3.60	
TCSPF(Cooling) Commercial /Residential	Hot		5.53/5.12	5.12/4.77	4.96/4.62	5.11/4.76	4.91/4.54	4.76/4.48	4.72/4.43	4.54/4.24	
	Average		5.62/4.64	5.07/4.28	4.84/4.04	5.14/4.32	4.84/3.97	4.74/4.11	4.68/4.00	4.58/3.86	
	Cold		6.00/4.77	5.35/4.32	5.06/4.02	5.46/4.43	5.10/3.98	4.99/4.16	4.92/4.02	4.86/3.95	
HSPF(Heating) Commercial /Residential	Hot		3.41/3.67	2.91/3.14	2.63/2.90	2.94/3.17	2.40/2.68	3.11/3.32	2.71/2.93	2.88/3.10	
	Average		4.06/3.72	3.57/3.38	3.55/3.40	3.63/3.57	3.46/3.44	3.67/3.54	3.43/3.36	3.54/3.40	
	Cold		3.67/3.25	3.31/3.03	3.33/3.07	3.40/3.23	3.31/3.17	3.40/3.17	3.23/3.07	3.30/3.06	
Indoor Unit	External Static Pressure-Range	Pa	35~270	50~290	50~290	60~285	60~285	60~295	60~295	60~310	
	Fan Motor Output	W	375	375	375	750	750	750	750	750	
	Air Flow[Hi2/Hi1/Hi/Med/Lo/SLo]	L/s	640/600/550/490/430/374	745/700/640/490/470/421	745/700/640/490/470/421	820/760/690/625/560/500	820/760/690/625/560/500	850/770/720/650/560/500	850/770/720/650/560/500	900/840/770/650/560/500	
	Sound Pressure Level [Hi2/Hi1/Hi/Med/Lo/SLo]	dB[A]	46/44/40/38/34/31	48/47/43/41/37/34	48/47/43/41/37/34	50/48/45/43/41/38	50/48/45/43/41/38	51/49/47/45/41/39	51/49/47/45/41/39	52/50/47/45/41/39	
	Sound Power Level	dB[A]	57	62	62	63	63	64	64	65	
	Dimension [W×H×D]	mm	1076×350×800	1076×350×800	1076×350×800	1300×350×890	1300×350×890	1300×350×890	1300×350×890	1300×350×890	
	Supply Air Spigot [W×H]	mm	980×222	980×222	980×222	1204×222	1204×222	1204×222	1204×222	1204×222	
	Return Air Spigot [W×H]	mm	934×308	934×308	934×308	1135×308	1135×308	1135×308	1135×308	1135×308	
	Packing [W×H×D]	mm	1310×464×970	1310×464×970	1310×464×970	1576×464×1060	1576×464×1060	1576×464×1060	1576×464×1060	1576×464×1060	
	Net/Gross Weight	kg	54/62	54/62	54/62	79/88	79/88	79/88	79/88	79/88	
	Drainage water pipe diameter	mm	VP25	VP25	VP25	VP25	VP25	VP25	VP25	VP25	
	Outdoor Unit	Compressor	Type	KTN150D42UFZD	ATH356SKRC9EQ	ATH356SKRC9EQ	ATH356SKRC9EQ	ATH356SKRC9EQ	ATH356SKRC9EQ	ATH356SKRC9EQ	ATH356SKRC9EQ
			R.L.A	9.3	11.5	11.5	11.5	11.5	11.5	11.5	11.5
Fan Motor		F.L.A	0.34	0.62	0.62	0.62	0.62	0.62	0.62	0.62	
Fan Motor Output		W	80	138	138	138	138	138	138	138	
Air Flow		m³/h	3290	4800	4800	8200	8200	8200	8200	8200	
Sound Pressure Level-Cooling		dB[A]	53	56	56	56	56	56	56	57	
Sound Pressure Level-Heating		dB[A]	54	57	57	57	57	57	57	59	
Sound Pressure Level-Night		dB[A]	51	54	54	54	54	54	54	54	
Sound Power Level		dB[A]	70	71	71	72	72	73	73	74	
Throttle Type			Electronic Expansion Value	Electronic Expansion Value	Electronic Expansion Value	Electronic Expansion Value	Electronic Expansion Value	Electronic Expansion Value	Electronic Expansion Value	Electronic Expansion Value	
Dimension [W×H×D]		mm	900×665×320	950×990×320	950×990×320	950×1380×320	950×1380×320	950×1380×320	950×1380×320	950×1380×320	
Packing [W×H×D]		mm	1056×717×427	1070×1120×470	1070×1120×470	1070×1520×470	1070×1520×470	1070×1520×470	1070×1520×470	1070×1520×470	
Net/Gross Weight		kg	44.0/48.0	86.5/100.5	86.5/100.5	98.5/109.0	98.5/109.0	108.0/118.5	108.0/118.5	108.0/118.5	
Refrigerant type /Quantity	Type		R32	R32	R32	R32	R32	R32	R32	R32	
	Charge	kg	1.4	3.0	3.0	3.1	3.1	3.4	3.4	3.4	
	GWP		675	675	675	675	675	675	675	675	
Design pressure	H/L	MPa	4.15/2.21	4.15/2.21	4.15/2.21	4.15/2.21	4.15/2.21	4.15/2.21	4.15/2.21	4.15/2.21	
Refrigerant pipe	Liquid side/Gas side	mm	Φ6.35/Φ12.7	Φ9.52/Φ15.88	Φ9.52/Φ15.88	Φ9.52/Φ15.88	Φ9.52/Φ15.88	Φ9.52/Φ15.88	Φ9.52/Φ15.88	Φ9.52/Φ15.88	
	Max. pipe length	m	75	75	75	75	75	75	75	75	
	Max. Height difference	m	30	30	30	30	30	30	30	30	
	Add Refrigerant Amount	g/m	18	35	35	35	35	35	35	35	
	Chargeless	m	30	30	30	30	30	30	30	30	
Guaranteed Temperature Operation Range	Cooling	°C	-5~52	-5~52	-5~52	-5~52	-5~52	-5~52	-5~52	-5~52	
	Heating	°C	-15~15.5	-15~15.5	-15~15.5	-15~15.5	-15~15.5	-15~15.5	-15~15.5	-15~15.5	

Specifications

4-WAY CASSETTE

IDU		PCI-2.0UFA1NQ	PCI-2.5UFA1NQ	PCI-3.0UFA1NQ	PCI-4.0UFA1NQ	PCI-4.0UFA1NQ	PCI-5.0UFA1NQ	PCI-5.0UFA1NQ	PCI-6.0UFA1NQ	PCI-6.0UFA1NQ	PCI-6.5UFA1NQ	PCI-6.5UFA1NQ	
ODU		PAS-2.0UFASNQ1	PAS-2.5UFASNQ1	PAS-3.0UFASNQ1	PAS-4.0UFASNQ1	PAS-4.0UFASNQ1	PAS-5.0UFASNQ1	PAS-5.0UFASNQ1	PAS-6.0UFASNQ1	PAS-6.0UFASNQ1	PAS-6.5UFASNQ1	PAS-6.5UFASNQ1	
Power supply (Indoor)	V/Ph/Hz	220-240~,50	220-240~,50	220-240~,50	220-240~,50	220-240~,50	220-240~,50	220-240~,50	220-240~,50	220-240~,50	220-240~,50	220-240~,50	
Power supply (Outdoor)	V/Ph/Hz	220-240~,50	220-240~,50	220-240~,50	220-240~,50	220-240~,50	380-415 3N~,50	220-240~,50	380-415 3N~,50	220-240~,50	380-415 3N~,50	220-240~,50	
Max. power input	kW	3.08	3.08	3.52	5.5	5.5	6.0	6.0	6.27	6.27	6.27	6.27	
Max. current input	A	14.0	14.0	16.0	25.0	12.0	27.3	12.0	28.5	12.0	28.5	12.0	
Cooling	Rated Capacity	kW	5.0	6.0	7.2	10.0	10.0	12.5	12.5	14.0	14.0	16.0	
	Capacity Range[Min~Max]	kW	1.5~6.0	1.5~7.5	2.5~8.6	3.2~12.0	3.2~12.0	4.0~14.2	4.0~14.2	5.0~16.0	5.0~16.0	6.0~18.0	
Heating	Rated Capacity	kW	6.0	7.5	8.6	11.5	11.5	14.0	14.0	16.0	16.0	18.0	
	Capacity Range[Min~Max]	kW	1.5~7.5	1.5~9.0	3.5~10.4	3.5~14.0	3.5~14.0	4.0~16.2	4.0~16.2	5.5~18.0	5.5~18.0	6.5~20.0	
Power consumption	Cooling	kW	1.14	1.46	1.97	2.50	2.63	3.38	3.38	4.00	4.00	4.80	
	Heating	kW	1.28	1.69	2.00	2.60	2.60	3.41	3.41	4.20	4.20	5.00	
EER	Cooling	kW/kW	4.39	4.10	3.65	3.80	3.80	3.70	3.70	3.50	3.50	3.14	
COP	Heating	kW/kW	4.69	4.27	4.30	4.40	4.40	4.10	4.10	3.80	3.80	3.60	
AEER	Cooling		4.25	4.00	3.62	3.70	3.70	3.60	3.60	3.40	3.40	3.12	
ACOP	Heating		4.60	4.20	4.20	4.30	4.30	4.00	4.00	3.70	3.70	3.50	
TCSPF(Cooling) Commercial /Residential	Hot		6.87/6.31	6.44/5.91	5.89/5.44	5.58/5.18	5.26/4.87	5.47/5.03	5.44/5.20	5.23/4.85	5.20/4.80	5.17/4.78	
	Average		6.92/5.51	6.44/5.16	5.97/4.89	5.57/4.61	5.19/4.24	5.48/4.45	5.44/4.44	5.31/4.43	5.23/4.30	5.30/4.39	
	Cold		7.33/5.56	6.84/5.24	6.37/5.03	5.90/4.68	5.46/4.24	5.84/4.55	5.78/4.53	5.68/4.58	5.57/4.41	5.71/4.59	
HSPF(Heating) Commercial /Residential	Hot		3.10/3.45	3.18/3.50	3.48/3.76	2.94/3.19	2.61/2.91	2.93/3.25	2.88/3.18	3.39/3.64	3.03/3.30	3.41/3.63	
	Average		4.37/4.30	4.26/4.13	4.24/3.96	3.69/3.47	3.71/3.60	4.03/3.91	3.94/3.85	4.02/3.79	3.84/3.60	3.94/3.72	
	Cold		4.08/3.83	3.94/3.65	3.84/3.45	3.42/3.10	3.50/3.26	3.75/3.48	3.68/3.45	3.65/3.31	3.52/3.18	3.58/3.26	
Indoor Unit	Fan Motor Output	W	60	60	60	127	127	127	127	127	127	127	
	Air Flow[Hi2/Hi1/Hi/Med/Lo/SLo]	L/s	350/310/275/250	350/310/275/250	390/350/310/250	510/470/390/300	510/470/390/300	570/510/470/350	570/510/470/350	570/510/470/350	570/510/470/350	610/550/510/450	
	Sound Pressure Level [Hi2/Hi1/Hi/Med/Lo/SLo]	dB[A]	39/36/33/30	39/36/33/30	41/39/36/33	47/44/40/33	47/44/40/33	49/47/44/36	49/47/44/36	49/47/44/36	49/47/44/36	50/48/46/43	
	Sound Power Level	dB[A]	50	50	52	58	58	60	60	60	63	63	
	Dimension [W×H×D]	mm	840×238×840	840×238×840	840×238×840	840×288×840	840×288×840	840×288×840	840×288×840	840×288×840	840×288×840	840×288×840	
	Packing [W×H×D]	mm	945×292×945	945×292×945	945×292×945	945×342×945	945×342×945	945×342×945	945×342×945	945×342×945	945×342×945	945×342×945	
	Net/Gross Weight	kg	23/27	23/27	23/27	27/31	27/31	27/31	27/31	27/31	27/31	27/31	
	Drainage water pipe diameter	mm	VP25	VP25	VP25	VP25	VP25	VP25	VP25	VP25	VP25	VP25	
	Outdoor Unit	Compressor	Type	KTN150D42UFZD	KTN150D42UFZD	KTM240D43UKT	ATH356SKRC9EQ	ATH356SKRC9EQ	ATH356SKRC9EQ	ATH356SKRC9EQ	ATH356SKRC9EQ	ATH356SKRC9EQ	ATH356SKRC9EQ
			R.L.A	7.7	7.7	9.3	11.5	11.5	11.5	11.5	11.5	11.5	11.5
Fan Motor		F.L.A	0.34	0.34	0.34	0.62	0.62	0.62	0.62	0.62	0.62	0.62	
		W	80	80	80	138	138	138	138	138	138	138	
Air Flow		m³/h	3290	3290	3290	4800	4800	8200	8200	8200	8200	8200	
Sound Pressure Level-Cooling		dB[A]	53	53	53	56	56	56	56	56	56	57	
Sound Pressure Level-Heating		dB[A]	54	54	54	57	57	57	57	57	57	59	
Sound Pressure Level-Night		dB[A]	51	51	51	54	54	54	54	54	54	54	
Sound Power Level		dB[A]	66	67	70	71	71	72	72	73	73	74	
Throttle Type			Electronic Expansion Value	Electronic Expansion Value	Electronic Expansion Value	Electronic Expansion Value	Electronic Expansion Value	Electronic Expansion Value	Electronic Expansion Value	Electronic Expansion Value	Electronic Expansion Value	Electronic Expansion Value	
Dimension [W×H×D]	mm	900×665×320	900×665×320	900×665×320	950×990×320	950×990×320	950×1380×320	950×1380×320	950×1380×320	950×1380×320	950×1380×320		
Packing [W×H×D]	mm	1056×717×427	1056×717×427	1056×717×427	1070×1120×470	1070×1120×470	1070×1520×470	1070×1520×470	1070×1520×470	1070×1520×470	1070×1520×470		
Net/Gross Weight	kg	42.0/45.5	42.0/45.5	44.0/48.0	86.5/100.5	86.5/100.5	98.5/109.0	98.5/109.0	108.0/118.5	108.0/118.5	108.0/118.5		
Refrigerant type /Quantity	Type	R32	R32	R32	R32	R32	R32	R32	R32	R32	R32	R32	
	Charge	kg	1.2	1.2	1.4	3.0	3.0	3.1	3.1	3.4	3.4	3.4	
	GWP		675	675	675	675	675	675	675	675	675	675	
Design pressure	H/L	MPa	4.15/2.21	4.15/2.21	4.15/2.21	4.15/2.21	4.15/2.21	4.15/2.21	4.15/2.21	4.15/2.21	4.15/2.21	4.15/2.21	
Refrigerant pipe	Liquid side/Gas side	mm	Φ6.35/Φ12.7	Φ6.35/Φ12.7	Φ6.35/Φ12.7	Φ9.52/Φ15.88	Φ9.52/Φ15.88	Φ9.52/Φ15.88	Φ9.52/Φ15.88	Φ9.52/Φ15.88	Φ9.52/Φ15.88	Φ9.52/Φ15.88	
	Max. pipe length	m	50	50	75	75	75	75	75	75	75		
	Max. Height difference	m	30	30	30	30	30	30	30	30	30		
	Add Refrigerant Amount	g/m	18	18	18	35	35	35	35	35	35		
	Chargeless	m	30	30	30	30	30	30	30	30	30		
Guaranteed Temperature Operation Range	Cooling	°C	-5~52	-5~52	-5~52	-5~52	-5~52	-5~52	-5~52	-5~52	-5~52	-5~52	
	Heating	°C	-15~15.5	-15~15.5	-15~15.5	-15~15.5	-15~15.5	-15~15.5	-15~15.5	-15~15.5	-15~15.5	-15~15.5	

Specifications

CEILING SUSPENDED

IDU		PPFC-2.0UFA1NQ	PPFC-2.5UFA1NQ	PPFC-3.0UFA1NQ	PPFC-4.0UFA1NQ	PPFC-4.0UFA1NQ	PPFC-5.0UFA1NQ	PPFC-5.0UFA1NQ	PPFC-6.0UFA1NQ	PPFC-6.0UFA1NQ	
ODU		PAS-2.0UFASNQ1	PAS-2.5UFASNQ1	PAS-3.0UFASNQ1	PAS-4.0UFASNQ1	PAS-4.0UFASMQ1	PAS-5.0UFASNQ1	PAS-5.0UFASMQ1	PAS-6.0UFASNQ1	PAS-6.0UFASMQ1	
Power supply (Indoor)	V/Ph/Hz	220-240~,50	220-240~,50	220-240~,50	220-240~,50	220-240~,50	220-240~,50	220-240~,50	220-240~,50	220-240~,50	
Power supply (Outdoor)	V/Ph/Hz	220-240~,50	220-240~,50	220-240~,50	220-240~,50	220-240~,50	220-240~,50	220-240~,50	220-240~,50	220-240~,50	
Max. power input	kW	3.08	3.08	3.52	5.5	5.5	6.0	6.0	6.27	6.27	
Max. current input	A	14.0	14.0	16.0	25.0	12.0	27.3	12.0	28.5	12.0	
Cooling	Rated Capacity	kW	5.0	6.0	7.2	10.0	10.0	12.5	12.5	14.0	14.0
	Capacity Range[Min~Max]	kW	1.5~6.0	1.5~7.5	2.5~8.6	3.2~12.0	3.2~12.0	4.0~14.2	4.0~14.2	5.0~16.0	5.0~16.0
Heating	Rated Capacity	kW	6.0	7.5	8.6	11.5	11.5	14.0	14.0	16.0	16.0
	Capacity Range[Min~Max]	kW	1.5~7.5	1.5~9.0	3.5~10.4	3.5~14.0	3.5~14.0	4.0~16.2	4.0~16.2	5.5~18.0	5.5~18.0
Power consumption	Cooling	kW	1.28	1.66	2.21	2.70	2.70	3.96	3.96	4.45	4.45
	Heating	kW	1.50	2.14	2.32	3.11	3.11	4.38	4.38	5.03	5.03
EER	Cooling	kW/kW	3.90	3.60	3.26	3.70	3.70	3.16	3.16	3.15	3.15
COP	Heating	kW/kW	4.00	3.50	3.70	3.70	3.70	3.20	3.20	3.18	3.18
AEER	Cooling		3.80	3.50	3.22	3.60	3.60	3.12	3.12	3.11	3.11
ACOP	Heating		3.90	3.40	3.66	3.60	3.60	3.16	3.16	3.14	3.14
TCSPF(Cooling) Commercial /Residential	Hot		5.43/5.03	5.17/4.78	5.13/4.76	5.20/4.83	5.16/4.77	4.89/4.50	4.88/4.50	4.70/4.37	5.58/5.12
	Average		5.38/4.42	5.17/4.25	5.17/4.31	5.20/4.33	4.96/4.16	4.93/4.03	4.78/4.01	5.65/4.56	
	Cold		5.68/4.42	5.48/4.32	5.51/4.43	5.50/4.39	5.35/4.17	5.30/4.15	5.25/4.12	5.10/4.15	6.06/4.72
HSPF(Heating) Commercial /Residential	Hot		2.69/2.93	2.82/3.07	3.25/3.50	2.95/3.22	2.57/2.85	2.70/2.96	2.78/3.03	2.95/3.14	2.73/2.96
	Average		3.42/3.18	3.58/3.42	3.90/3.65	3.82/3.71	3.59/3.47	3.55/3.47	3.52/3.27	3.46/3.34	3.44/3.33
	Cold		3.19/3.18	3.33/3.07	3.55/3.21	3.55/3.32	3.38/3.13	3.33/3.13	3.26/2.92	3.21/3.00	3.21/3.01
Indoor Unit	Fan Motor Output	W	100	100	181	181	181	181	181	181	
	Air Flow[Hi2/Hi1/Hi/Med/Lo/SLo]	L/s	220/200/180/150	255/230/190/150	355/330/280/230	480/420/370/320	480/420/370/320	480/440/390/350	480/440/390/350	550/480/410/370	550/480/410/370
	Sound Pressure Level [Hi2/Hi1/Hi/Med/Lo/SLo]	dB[A]	41/39/35/33	45/41/39/33	45/41/39/33	49/44/42/39	49/44/42/39	49/46/43/41	49/46/43/41	52/49/45/41	52/49/45/41
	Sound Power Level	dB[A]	57	61	60	65	65	65	65	68	68
	Dimension [W×H×D]	mm	990×230×680	990×230×680	1580×230×680	1580×230×680	1580×230×680	1580×230×680	1580×230×680	1580×230×680	1580×230×680
	Packing [W×H×D]	mm	1110×340×830	1110×340×830	1690×340×830	1690×340×830	1690×340×830	1690×340×830	1690×340×830	1690×340×830	1690×340×830
	Net/Gross Weight	kg	32/37	32/37	48/55	48/55	48/55	48/55	48/55	48/55	48/55
	Drainage water pipe diameter	mm	VP25	VP25	VP25	VP25	VP25	VP25	VP25	VP25	VP25
	Compressor	Type	KTN150D42UFZD	KTN150D42UFZD	KTM240D43UKT	ATH356SKRC9EQ	ATH356SKRC9EQ	ATH356SKRC9EQ	ATH356SKRC9EQ	ATH356SKRC9EQ	ATH356SKRC9EQ
	R.L.A	7.7	7.7	9.3	11.5	11.5	11.5	11.5	11.5	11.5	
Fan Motor	F.L.A	0.34	0.34	0.34	0.62	0.62	0.62	0.62	0.62	0.62	
Fan Motor Output	W	80	80	80	138	138	138	138	138	138	
Air Flow	m³/h	3290	3290	3290	4800	4800	8200	8200	8200	8200	
Sound Pressure Level-Cooling	dB[A]	53	53	53	56	56	56	56	56	56	
Sound Pressure Level-Heating	dB[A]	54	54	54	57	57	57	57	57	57	
Sound Pressure Level-Night	dB[A]	51	51	51	54	54	54	54	54	54	
Sound Power Level	dB[A]	66	67	70	71	71	72	72	73	73	
Throttle Type		Electronic Expansion Value	Electronic Expansion Value	Electronic Expansion Value	Electronic Expansion Value	Electronic Expansion Value	Electronic Expansion Value	Electronic Expansion Value	Electronic Expansion Value	Electronic Expansion Value	
Dimension [W×H×D]	mm	900×665×320	900×665×320	900×665×320	950×990×320	950×990×320	950×1380×320	950×1380×320	950×1380×320	950×1380×320	
Packing [W×H×D]	mm	1056×717×427	1056×717×427	1056×717×427	1070×1120×470	1070×1120×470	1070×1520×470	1070×1520×470	1070×1520×470	1070×1520×470	
Net/Gross Weight	kg	42.0/45.5	42.0/45.5	44.0/48.0	86.5/100.5	86.5/100.5	98.5/109.0	98.5/109.0	108.0/118.5	108.0/118.5	
Refrigerant type /Quantity	Type	R32	R32	R32	R32	R32	R32	R32	R32	R32	
	Charge	kg	1.2	1.2	1.4	3.0	3.0	3.1	3.1	3.4	3.4
	GWP		675	675	675	675	675	675	675	675	675
Design pressure	H/L	MPa	4.15/2.21	4.15/2.21	4.15/2.21	4.15/2.21	4.15/2.21	4.15/2.21	4.15/2.21	4.15/2.21	
Refrigerant pipe	Liquid side/Gas side	mm	Φ6.35/Φ12.7	Φ6.35/Φ12.7	Φ6.35/Φ12.7	Φ9.52/Φ15.88	Φ9.52/Φ15.88	Φ9.52/Φ15.88	Φ9.52/Φ15.88	Φ9.52/Φ15.88	
	Max. pipe length	m	50	50	75	75	75	75	75	75	
	Max. Height difference	m	30	30	30	30	30	30	30	30	
	Add Refrigerant Amount	g/m	18	18	18	35	35	35	35	35	
	Chargeless	m	30	30	30	30	30	30	30	30	
Guaranteed Temperature Operation Range	Cooling	°C	-5~52	-5~52	-5~52	-5~52	-5~52	-5~52	-5~52	-5~52	
	Heating	°C	-15~15.5	-15~15.5	-15~15.5	-15~15.5	-15~15.5	-15~15.5	-15~15.5	-15~15.5	



Temperzone Ltd

ENQUIRIES

ausales@temperzone.com
nzsales@temperzone.com

AUSTRALIA

Sydney: (02) 8822 5700
Melbourne: (03) 8769 7600
Brisbane: (07) 3308 8333
Adelaide: (08) 8115 2111

DISTRIBUTORS

Newcastle: (02) 4962 1155
Perth: (08) 6399 5900
Launceston: (03) 6331 4209

NEW ZEALAND

Auckland: (09) 279 5250
Hamilton: (07) 839 2705
Wellington: (04) 569 3262
Christchurch: (03) 379 3216

Hitachi Cooling & Heating Official Distributor



WARRANTY

hitachiaircon.com.au
hitachiaircon.co.nz



The specifications of this catalogue may change without prior notice to allow Hitachi Cooling & Heating to incorporate the latest innovations for its customers. The information contained in this catalog is merely informative. Hitachi Cooling & Heating declines any responsibility in the broadest sense, for damage, direct or indirect, arising from the use and / or interpretation of the recommendations in this catalogue.