

HITACHI

# OPERATION INSTALLATION & MAINTENANCE MANUAL

**air**Core 700  
SINGLE SPLIT  
INVERTER SERIES  
INDOOR UNITS

## MODELS HIGH ESP DUCTED TYPE

PPIH-3.0UFA1NQ  
PPIH-4.0UFA1NQ  
PPIH-5.0UFA1NQ  
PPIH-6.0UFA1NQ  
PPIH-6.5UFA1NQ

EN INSTRUCTION MANUAL

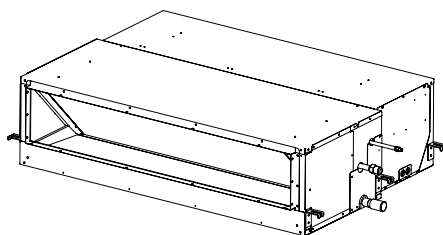
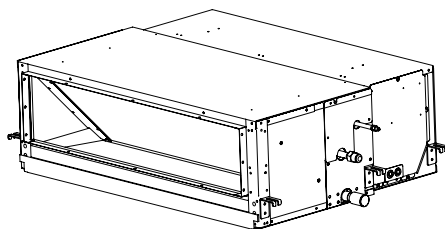

Scan the code to get the electronic manual.

Cooling & Heating

P02131Q

air



# IMPORTANT NOTICE

- Hitachi pursues a policy of continuous improvement in design and performance of products. The right is therefore reserved to vary specifications without notice.
- Hitachi cannot anticipate every possible circumstance that might involve a potential hazard.
- This heat pump air conditioner is designed for human comfort air conditioning only. Do not use this heat pump air conditioner for other purposes such as drying clothes, refrigerating foods or for any other cooling or heating purposes.
- Signal words (DANGER, WARNING, CAUTION, NOTICE, NOTE) are used to identify levels of hazard seriousness. Definitions for identifying hazard levels are provided below with their respective signal words.



**DANGER**

**DANGER** indicates a hazardous situation which, if not avoided, will result in death or serious injury.



**WARNING**

**WARNING** indicates a hazardous situation which, if not avoided, could result in death or serious injury.



**CAUTION**

**CAUTION** indicates a hazardous situation which, if not avoided, could result in minor or moderate injury.



**NOTICE**

**NOTICE** is used to address practices not related to physical injury.

**NOTE:**

**NOTE** is useful information for operation and/or maintenance.

- Do not install the unit in the place where silicon gas drifts. If the silicon gas attaches to the surface of heat exchanger, the fin surface repels water. As a result, drain water splashes outside of the drain pan and splashed water runs inside of electrical box. In the end, water leakage or electrical devices failure may occur.
- Pay attention to the following points when the unit is installed in a hospital or other facilities where an electromagnetic wave generates from a medical equipment.
  - Do not install the unit in the place where an electromagnetic wave is directly radiated to the electrical box, remote control cable or remote control switch.
  - Install the unit at least 3 meters away from an electromagnetic wave such as a radio.
- This unit shall be installed in accordance with local codes and regulations.
- The installer and system specialist shall ensure safety against the refrigerant leakage according to local regulations or standards. The following standards may be applicable, if local regulations are not available. International Organization for Standardization, ISO5149 or European Standard, EN378 or Japan Standard, KHKS0010.
- No part of this manual may be reproduced without written permission.
- It is assumed that this heat pump air conditioner will be operated and serviced by persons conversant in English. If this is not the case, the distributor should add safety, caution and operating signs in the native language.
- If you have any questions, contact your distributor or dealer of Hitachi.
- This manual gives a common description and information for this heat pump air conditioner which you operate as well for other models.
- This system has been designed and tested to operate within the indoor temperature limits as stated below. The manufacturer cannot guarantee satisfactory performance if the unit is operated for prolonged periods outside of these limits.

°C

Temperature Range	Maximum	Minimum
Cooling Operation	32 DB/23 WB	21 DB/15 WB
Heating Operation	27 DB	20 DB

DB: Dry Bulb , WB: Wet Bulb

- This manual should be considered as a permanent part of the air conditioning equipment and should remain with the air conditioning equipment.

 **DANGER**

- Do not install pipe work with diameters that are not specified for that model.
- Do not ground units to water pipes, gas pipes, telephone wires, or lightning rods as incomplete grounding can cause a severe shock hazard resulting in severe injury or death. Additionally, grounding to gas pipes could cause a gas leak and potential explosion causing severe injury or death.
- Do not install unit in an area where flammable materials are present due to risk of explosions that can cause serious injury or death.
- Safely dispose all packing and transportation materials in accordance with federal/state/local laws or ordinances. Packing materials such as nails and other metal or wood parts, including plastic packing materials used for transportation may cause injuries or death by suffocation.
- Refrigerant gas is heavier than air and replaces oxygen. A massive leak can lead to oxygen depletion, especially in basements, and an asphyxiation hazard could occur leading to serious injury or death.
- If refrigerant gas leaks during installation, ventilate the area immediately. Refrigerant gas may produce toxic gas if it comes into contact with fire. Exposure to this gas could cause severe injury or death.

 **WARNING**

- Assure that the maximum operating pressure is checked when connecting to Outdoor UNIT.
- This unit <PPIH-UFA1NQ> is a PARTIAL UNIT AIR CONDITIONER, shall only be connected to an appliance suitable for the same refrigerant.
- This unit <PPIH-UFA1NQ> is a PARTIAL UNIT AIR CONDITIONER, complying with PARTIAL UNIT requirements of IEC 60335-1 and IEC 60335-2-40, and must only be connected to other units that have been confirmed as complying to corresponding PARTIAL UNIT requirements of IEC 60335-1 and IEC 60335-2-40.
- Only qualified personnel licensed or certified in their jurisdiction must carry out the installation work. Installation must be done in accordance with this installation manual. Improper installation may result in water leakage, electric shock, or fire.
- Pipe work and installation shall be also in compliance with national codes.
- Use only specified accessories and parts for installation work. Failure to use specified parts may result in water leakage, electric shock, fire, or the unit falling.
- Install the air conditioner or heat pump on a foundation strong enough that it can withstand the weight of the unit. A foundation of insufficient strength may result in the unit falling and causing injuries.
- Take into account strong winds, typhoons, or earthquakes when installing. Improper installation may result in the unit falling and causing accidents.
- Make sure that a separate power supply circuit is provided for this unit and that all electrical work is carried out by qualified personnel licensed or certified in their jurisdiction according to local, state, and national regulations. An insufficient power supply capacity or improper electrical construction may lead to electric shock or fire.
- Make sure that all wiring is secured, that specified wires are used, and that no external forces act on the terminal connections or wires. Improper connections or installation may result in fire.
- When wiring, position the wires so that the electrical wiring box cover can be securely fastened. Improper positioning of the electrical wiring box cover may result in electric shock, fire, or the terminals overheating.

- Before touching electrical parts, turn off the unit.
- The circuit must be protected with safety devices in accordance with local and national codes, i.e. a circuit breaker.
- Securely fasten the outdoor unit terminal cover (panel). If the terminal cover/panel is not installed properly, dust or water may enter the outdoor unit causing fire or electric shock.
- When a fire occurs, cut off the power supply immediately.



- Do not touch the switch with wet fingers. Touching a switch with wet fingers can cause electric shock.
- This appliance is not intended for use by persons (including children) with reduced physical, sensory or mental capabilities, or lack of experience and knowledge, unless they have been given supervision or instruction concerning use of the appliance by a person responsible for their safety. Children should be supervised to ensure that they do not play with the appliance.
- Wear adequate personal protective equipment (protective gloves, safety glasses,...) when installing, maintaining or servicing the system.
- The heat exchanger fins are sharp enough to cut. To avoid injury, wear gloves or cover the fins while working around them.
- Do not touch the refrigerant pipes during and immediately after operation as the refrigerant pipes may be hot or cold, depending on the condition of the refrigerant flowing through the refrigerant piping, compressor, and other refrigerant cycle parts. Your hands may suffer burns or frostbite if you touch the refrigerant pipes. To avoid injury, give the pipes time to return to normal temperature or, if you must touch them, be sure to wear proper gloves.
- Install drain piping to ensure proper drainage. Improper drain piping may result in water leakage and property damage.
- Insulate piping to prevent condensation.
- Be careful when transporting the product.
- Do not install the air conditioner or heat pump in the following locations:
  - Where a mineral oil mist or oil spray or vapor is produced, for example, in a kitchen. Plastic parts may deteriorate and fall off or result in water leakage.
  - Where corrosive gas, such as sulfurous acid gas, is produced. Corroding copper pipes or soldered parts may result in refrigerant leakage.
  - Near machinery emitting electromagnetic waves. Electromagnetic waves may disturb the operation of the control system and cause the unit to malfunction.
  - Where flammable gas may leak, where there is carbon fiber, or ignitable dust suspension in the air, or where volatile flammables such as thinner or gasoline are handled. Operating the unit in such conditions can cause a fire.
- Take adequate measures to prevent the outdoor unit from being used as a shelter by small animals. Small animals making contact with electrical parts can cause malfunctions, smoke, or fire. Instruct the user to keep the area around the unit clean.
- This appliance can be used by children aged from 8 years and above and persons with reduced physical, sensory or mental capabilities or lack of experience and knowledge if they have been given supervision or instruction concerning use of the appliance in a safe way and understand the hazards involved. Cleaning and user maintenance shall not be made by children without supervision.
- Use shielded wires of operation line between the indoor and the outdoor unit. And connect the shielded part to the earth screw in the electrical box of the indoor unit as shown in the Fig. 1.

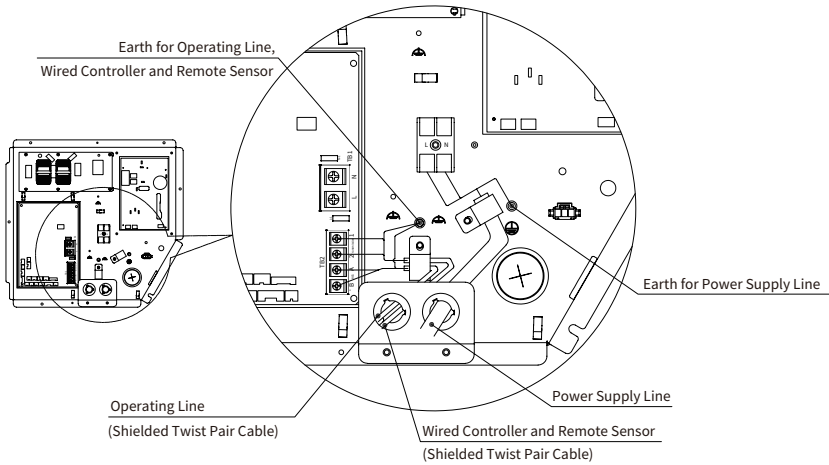

Fig.1 Earth Wiring

**NOTES:**

- The indoor unit should be positioned where the unit and interunit wires (outdoor to indoor) are at least 3.3ft (1m) away from any televisions or radios. (The unit may cause interference with the picture or sound.) Depending on the radio waves, a distance of 3.3ft (1m) may not be sufficient to eliminate the noise.
- Dismantling the unit, treatment of the refrigerant, oil and additional parts must be done in accordance with the relevant local, state, and national regulations.
- As maximum allowable pressure is 4.15MPa, minimum allowable pressure is 2.21MPa, the wall thickness of field-installed pipes should be selected in accordance with the relevant local, state, and national regulations.

Explanation of symbols displayed on the indoor unit or outdoor unit

	<b>WARNING</b>	These symbols shows that appliance uses a flammable refrigerant. If the refrigerant is leaked and exposed to an external ignition source, there is a risk of fire.
	<b>CAUTION</b>	This symbol shows that the operation manual should be read carefully.
	<b>CAUTION</b>	This symbol shows that a service personnel should be handling this equipment with reference to the installation manual.
	<b>CAUTION</b>	This symbol shows that information is available such as the operating manual or installation manual.

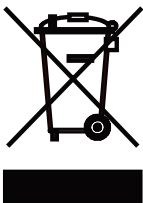

**Correct Disposal of this product**

This marking indicates that this product should not be disposed with other household wastes. To prevent possible harm to environment or human health from uncontrolled waste disposal, recycle it responsibly to promote the sustainable reuse of material resources. To return your used device, please use the return and collection systems or contact the retailer where the product was purchased. They can take this product for environmental safe recycling.

## Precautions for R32

**This air conditioner uses R32 flammable refrigerant.** Air conditioner with R32 refrigerant, if not be treated carefully, may cause serious harm to the human body or surrounding things. Please read the following instructions carefully before installing, using and maintaining.



- Do not use means to accelerate the defrosting process or to clean, other than those recommended by the manufacturer.
- The appliance shall be stored in a room without continuously operating ignition sources (for example: open flames, an operating gas appliance or an operating electric heater).
- Do not pierce or burn the refrigerant system to avoid the leakage.
- Be aware that refrigerants might not contain an odour.
- Do not charge R32 into system other than those designated for R32.  
Do not charge R32 system with oil other than those designated for R32.
- Do not use a reclaim cylinder other than an R32 reclaim cylinder.
- Be sure to only use refrigerant piping approved for use with R32 refrigerant. The use of unapproved piping may result in explosive rupture.
- The pipe-work shall be securely mounted and guarded from physical damage.
- The national gas regulations shall also be observed when field-installed refrigerant pipes are required.
- Field-made refrigerant joints indoors shall be tightness tested. The test method shall have a sensitivity of 5 grams per year of refrigerant or better under a pressure of at least 0,25 times the maximum allowable pressure. No leak shall be detected; Mechanical connections shall be accessible for maintenance purposes.
- The joints shall not be reused, unless after re-flaring the pipe.
- Joints made in the installation between parts of the refrigerating system, with outdoor part charged, shall be made in accordance with the following.
  - A brazed, welded, or mechanical connection shall be made before opening the valves to permit refrigerant to flow between the refrigerating system parts. A vacuum valve shall be provided to evacuate the interconnecting pipe and/or any uncharged refrigerating system part.
  - Mechanical connectors used indoors shall comply with ISO 14903. When mechanical connectors are reused indoors, sealing parts shall be renewed. When flared joints are reused indoors, the flare part shall be re-fabricated.
  - Refrigerant tubing shall be protected or enclosed to avoid damage.
- That after completion of field piping for split systems, the field pipework shall be pressure tested with an inert gas and then vacuum tested prior to refrigerant charging, according to the following requirements:
  - The minimum test pressure for the low side of the system shall be the low side design pressure and the minimum test pressure for the high side of the system shall be the high side design pressure, unless the high side of the system, cannot be isolated from the low side of the system in which case the entire system shall be pressure tested to the low side design pressure.
- The appliance shall be stored in a well-ventilated area where the room size corresponds to the room area as specified.
- The appliances are designed for use at altitudes less than 2000m, may cause serious harm to the human body or surrounding things if used at altitudes 2000m and above.
- Keep any required ventilation openings clear of obstruction, don't block air inlet or air outlet, Otherwise, the cooling or heating capacity will be weakened, even cause system stop operating or

safety hazard.

- Maintenance or repair of air conditioner using R32 refrigerant must be carried out after security check to minimize risk of incidents.
- Ensure no following objects under the indoor unit:
  - Microwaves, ovens and other hot objects.
  - Computers and other high electrostatic appliances.
  - Sockets that plug frequently.
- Installation, maintenance, service, repairing, removing and disposal operations, shall only be performed by the qualified personnel or recommended by the manufacturer.
- Every working procedure that affects safety means shall only be carried out by competent persons. Examples for such working procedures are:
  - breaking into the refrigerating circuit;
  - opening of sealed components;
  - opening of ventilated enclosures.
- Precautions shall be taken to avoid excessive vibration or pulsation to refrigerating piping for the transport and installation.
- Protection devices, piping and fittings shall be protected as far as possible against adverse environmental effects, for example the danger of water collecting and freezing in relief pipes or the accumulation of dirt and debris.
- When installing or repairing the air conditioner and the connecting line is not long enough, the entire connecting line shall be replaced with the connecting line of the original specification; extension is not allowed.
- Refrigerating systems shall be so installed as to minimize the likelihood of hydraulic shock damaging the system.
- The appliance shall be stored and installed so as to prevent mechanical damage from occurring.
- Work shall be undertaken under a controlled procedure so as to minimise the risk of a flammable gas or vapour being present while the work is being performed.
- All maintenance staff and others working in the local area shall be instructed on the nature of work being carried out. Work in confined spaces shall be avoided.
- The area shall be checked with an appropriate refrigerant detector prior to and during work, to ensure the non-existence of potentially toxic or flammable atmospheres. Ensure that the leak detection equipment being used is suitable for use with all applicable refrigerants, i.e. nonsparking, adequately sealed or intrinsically safe.
- If any hot work is to be conducted on the refrigerating equipment or any associated parts, appropriate fire extinguishing equipment shall be available to hand. Have a dry powder or CO<sub>2</sub> fire extinguisher adjacent to the charging area.
- No person carrying out work in relation to a refrigerating system which involves exposing any pipe work shall use any sources of ignition in such a manner that it can lead to the risk of fire or explosion. All possible ignition sources, including cigarette smoking, should be kept sufficiently far away from the site of installation, repairing, removing and disposal, during which refrigerant can possibly be released to the surrounding space. Prior to work taking place, the area around the equipment is to be surveyed to make sure that there are no flammable hazards or ignition risks. "No Smoking" signs shall be displayed.
- Ensure that the area is in the open or that it is adequately ventilated before breaking into the system or conducting any hot work. A degree of ventilation shall continue during the period that the work is carried out. The ventilation should safely disperse any released refrigerant and preferably expel it externally into the atmosphere.



- Anti-static precautions is necessary for installing and maintenance, for example, wear pure cotton clothes and gloves.
- If R32 refrigerant leakage occurs during the installation, operators shall immediately detect the concentration in indoor environment until it reaches a safe level. If the leakage affects the performance of the machine, please immediately stop the operation, and the air conditioner must be vacuumed firstly and be returned to the maintenance station for processing.
- Where electrical components are being changed, they shall be fit for the purpose and to the correct specification. At all times the maintenance and service guidelines of this manual shall be followed. If in doubt, consult the manufacturer's technical department for assistance. The following checks shall be applied to installations using R32:
  - The refrigerant charge is in accordance with the room size within which the refrigerant containing parts are installed.
  - The ventilation machinery and inlets and outlets are operating adequately and are not obstructed; and shall keep away from heat source, inflammable or explosive conditions.
  - Marking to the equipment continues to be visible and legible. Markings and signs that are illegible shall be corrected.
  - Refrigerating pipe or components are installed in a position where they are unlikely to be exposed to any substance which can corrode refrigerant containing components, unless the components are constructed of materials which are inherently resistant to being corroded or are suitably protected against being so corroded.
- Repair and maintenance to electrical components shall include initial safety checks and component inspection procedures. If a fault exists that could compromise safety, then no electrical supply shall be connected to the circuit until it is satisfactorily dealt with. If the fault cannot be corrected immediately but it is necessary to continue operation, an adequate temporary solution shall be used. This shall be reported to the owner of the equipment so all parties are advised. Initial safety checks shall include:
  - that capacitors are discharged: this shall be done in a safe manner to avoid possibility of sparking.
  - that no live electrical components and wiring are exposed while charging, recovering or purging the system.
  - that there is continuity of earth bonding.
- Sealed electrical components shall not be repaired.
- Check that cabling will not be subject to wear, corrosion, excessive pressure, vibration, sharp edges or any other adverse environmental effects. The check shall also take into account the effects of aging or continual vibration from sources such as compressors or fans.
- Under no circumstances shall potential sources of ignition be used in the searching for or detection of refrigerant leaks. A halide torch (or any other detector using a naked flame) shall not be used.
- Air-tightness test shall be carried out as guaranteed. Charging oxygen, acetylene or other inflammable and toxic gases during leakage inspection and air-tightness test may lead to explosions. It recommended to use nitrogen gas for this test.
- The following leak detection methods are deemed acceptable for all refrigerant systems.
  - Electronic leak detectors may be used to detect refrigerant leaks but, in the case of flammable refrigerants, the sensitivity can be inadequate, or can need re-calibration. (Detection equipment shall be calibrated in a refrigerant-free area.) Ensure that the detector is not a potential source of ignition and is suitable for the refrigerant used. Leak detection equipment shall be set at a percentage of the LFL of the refrigerant and shall be calibrated to the refrigerant employed, and the appropriate percentage of gas (no more than 25 %) is confirmed.
  - The fluid used in leak detection is applicable to most refrigerants. But do not use chloride solvents to prevent the reaction between chlorine and refrigerants and the corrosion of copper pipeline.
  - If a leak is suspected, all naked flames shall be removed/extinguished.

- If a leakage of refrigerant is found which requires brazing, all of the refrigerant shall be recovered from the system, or isolated in a part of the system remote from the leak. Removal of refrigerant shall be according to this manual.
- When breaking into the refrigerant circuit to make repairs – or for any other purpose – conventional procedures shall be used. However, for flammable refrigerants it is important that best practice is followed since flammability is a consideration. The following procedure shall be adhered to:
  - safely remove refrigerant following local and national regulations;
  - evacuate;
  - purge the circuit with inert gas;
  - continuously flush with inert gas when using flame to open circuit;
  - open the circuit.
- The refrigerant charge shall be recovered into the correct recovery cylinders.
- Purging of the refrigerant circuit shall be achieved by breaking the vacuum in the system with inert gas and continuing to fill until the working pressure is achieved, then venting to atmosphere, and finally pulling down to a vacuum. This process shall be repeated until no refrigerant is within the system. The system shall be vented down to atmospheric pressure to enable work to take place.
- Ensure that the outlet of the vacuum pump is not close to any potential ignition sources and that ventilation is available.
- In addition to conventional charging procedures, the following requirements shall be followed.
  - Ensure that contamination of different refrigerants does not occur when using charging equipment. Hoses or lines shall be as short as possible to minimise the amount of refrigerant contained in them.
  - Cylinders shall be kept in an appropriate position according to the instructions.
  - Ensure that the refrigerating system is earthed prior to charging the system with refrigerant.
  - Label the system when charging is complete (if not already labelled).
  - Extreme care shall be taken not to overfill the refrigerating system.
- Prior to recharging the system, it shall be pressure-tested with the appropriate purging gas. The system shall be leak-tested on completion of charging but prior to commissioning. A follow up leak test shall be carried out prior to leaving the site.
- Before carrying out the decommissioning procedure, it is essential that the technician is completely familiar with the equipment and all its detail. It is recommended good practice that all refrigerants are recovered safely. Prior to the task being carried out, an oil and refrigerant sample shall be taken in case analysis is required prior to re-use of recovered refrigerant. It is essential that electrical power is available before the task is commenced.
  - Become familiar with the equipment and its operation.
  - Isolate system electrically.
  - Before attempting the procedure, ensure that:
    - (a) mechanical handling equipment is available, if required, for handling refrigerant cylinders;
    - (b) all personal protective equipment is available and being used correctly;
    - (c) the recovery process is supervised at all times by a competent person;
    - (d) recovery equipment and cylinders conform to the appropriate standards.
  - Pump down refrigerant system, if possible.
  - If a vacuum is not possible, make a manifold so that refrigerant can be removed from various parts of the system.
  - Make sure that the cylinder is situated on the scales before recovery takes place.
  - Start the recovery machine and operate in accordance with instructions.
  - Do not overfill cylinders (no more than 80% volume liquid charge).
  - Do not exceed the maximum working pressure of the cylinder, even temporarily.
  - When the cylinders have been filled correctly and the process completed, make sure that the

cylinders and the equipment are removed from site promptly and all isolation valves on the equipment are closed off.

- Recovered refrigerant shall not be charged into another refrigerating system unless it has been cleaned and checked.
- Equipment shall be labelled stating that it has been de-commissioned and emptied of refrigerant. The label shall be dated and signed. For appliances containing flammable refrigerants, ensure that there are labels on the equipment stating the equipment contains flammable refrigerant.
- When removing refrigerant from a system, either for servicing or decommissioning, it is required to follow good practice so that all refrigerants are removed safely.
- When transferring refrigerant into cylinders, ensure that only appropriate refrigerant recovery cylinders are employed. Ensure that the correct number of cylinders for holding the total system charge is available. All cylinders to be used are designated for the recovered refrigerant and labelled for that refrigerant (i.e. special cylinders for the recovery of refrigerant). Cylinders shall be complete with pressure-relief valve and associated shut-off valves in good working order. Empty recovery cylinders are evacuated and, if possible, cooled before recovery occurs.
- The recovery equipment shall be in good working order with a set of instructions concerning the equipment that is at hand and shall be suitable for the recovery of the flammable refrigerant. Consult manufacturer if in doubt. In addition, a set of calibrated weighing scales shall be available and in good working order. Hoses shall be complete with leak-free disconnect couplings and in good condition.
- The recovered refrigerant shall be processed according to local legislation in the correct recovery cylinder, and the relevant waste transfer note arranged. Do not mix refrigerants in recovery units and especially not in cylinders.
- If compressors or compressor oils are to be removed, ensure that they have been evacuated to an acceptable level to make certain that flammable refrigerant does not remain within the lubricant. The compressor body shall not be heated by an open flame or other ignition sources to accelerate this process. Draining of oil from a system shall be carried out safely.
- Disposal of equipment shall follow the national regulations.
- The storage of the appliance should be in accordance with the applicable regulations or instructions, whichever is more stringent.
- The maximum number of pieces of equipment permitted to be stored together notes by each product package information and standard following ISO 780-2015.
- After completing the installation work, check that the refrigerant gas does not leak throughout the system.
- When installing the unit in a small room, take measures to keep the refrigerant concentration from exceeding allowable safety limits. Excessive refrigerant leaks, in the event of an accident in a closed ambient space, can lead to oxygen deficiency.
- When installing or relocating the air conditioner, do not let any other substances besides R32, such as air, enter the refrigerant circuit. The presence of air or foreign matter in the refrigerant circuit causes an abnormal pressure rise, which may result in equipment damage and even injury.
- Refrigerant R32 in the system must be kept clean, dry, and tight.
  - Clean and Dry -- Foreign materials (including mineral oils such as SUNISO oil or moisture) should be prevented from getting into the system.
  - Tight -- R32 does not contain any chlorine, does not destroy the ozone layer, and does not reduce the earth's protection against harmful ultraviolet radiation. R32 can contribute to the greenhouse effect if it is released.
- Only use tools for R32, such as a gauge manifold, charge hose, gas leak detector, reverse flow check valve, refrigerant charge base, vacuum gauge, or refrigerant recovery equipment.

- If the conventional refrigerant and refrigerator oil are mixed in R32, the refrigerant may deteriorate.
- For Ducts indoor units, it shall not contain a potential ignition source in the duct system, such as electrical heating.
- For Duct indoor units, when connected via an air duct system to one or more rooms, the supply and return air shall be directly ducted to the space. Open areas such as false ceilings shall not be used as a return air duct.
- Duct indoor units that connected via an air duct system to one or more rooms, auxiliary devices which can be a potential ignition source shall not be installed in the ductwork. Examples of such potential ignition sources are hot surfaces and electric switching devices.
- Duct indoor units that connected via an air duct system to one or more rooms are installed in a room with an area less than  $A_{min}$  [ $A_{min}(m^2)$  - see table below], that room shall be without continuously operating open flames (for example an operating gas appliance) or other potential ignition sources (for example an operating electric heater, hot surfaces). A flame-producing device may be installed in the same space if the device is provided with an effective flame arrestor.
- Appliance shall be installed, operated and stored in a room with a floor area larger than  $A_{min}$  ( $m^2$ ) [ $A_{min}(m^2)$  - see table below].
- The installation of pipe-work shall be kept to a room with a floor area larger than  $A_{min}(m^2)$  [ $A_{min}(m^2)$  - see table below].
- The unit has requirements on the minimum required room area ( $A_{min}$ ) used with different refrigerant charging amount (m). The total amount of refrigerant charged in the system corresponds to the room area installed in the table below. The calculation result is based on the Ducted-mounted unit, and the installation height is no less than 2.2m.

Minimum required room area for each refrigerant amount charged

Ducted-mounted units (No sensor, each room shall be assessed separately)			
Installation Height:2.2m			
m(kg)	$A_{min}(m^2)$	m(kg)	$A_{min}(m^2)$
≤1.842	-	3.40	10.068
1.843	5.458	3.60	10.660
2.00	5.922	3.80	11.253
2.20	6.515	4.00	11.845
2.40	7.107	4.20	12.437
2.60	7.699	4.40	13.029
2.80	8.291	4.60	13.622
3.00	8.884	4.80	14.585
3.20	9.476	5.00	15.826

## CHECKING PRODUCT RECEIVED

- Upon receiving this product, inspect it for any shipping damage. Claims for damage, either apparent or concealed, should be filed immediately with the shipping company.
- Check the model number, electrical characteristics (power supply, voltage and frequency) and accessories to determine if they are correct.

The standard utilization of the unit shall be explained in these instructions. Therefore, the utilization of the unit other than those indicated in these instructions is not recommended. Please contact your local agent, as the occasion arises.

Hitachi's liability shall not cover defects arising from the alteration performed by a customer without Hitachi's consent in a written form.

# Table of Contents

1. Safety Summary .....	1
2. Structure .....	3
2.1 Name of Parts .....	3
2.2 Necessary Tools and Instrument List for Installation .....	4
3. Transportation and Handling .....	4
3.1 Transportation.....	4
3.2 Handling of Indoor Unit .....	4
4. Indoor Unit Installation.....	5
4.1 Factory-Supplied Accessories.....	5
4.2 Initial Check.....	6
4.3 Installation.....	6
5. Refrigerant Piping Work .....	12
5.1 Piping Materials.....	12
5.2 Piping Connection.....	12
6. Drain Piping .....	14
7. Electrical Wiring.....	15
7.1 General Check .....	15
7.2 Electrical Wiring Connection .....	15
7.3 Field Minimum Wire Sizes for Power Source.....	17
7.4 DIP Switch Setting.....	18
7.5 Setting of External Static Pressure .....	20
8. Test Run .....	20
9. Safety and Control Device Setting.....	20
10. System Description .....	21
11. Wired remote controller .....	21
12. Before Operation .....	22
13. Operation Method .....	22
14. Automatic Control .....	22
15. Filter Cleaning.....	23
16. Troubleshooting.....	23
16.1 If Trouble Still Remains .....	23
16.2 No Operation .....	23
16.3 Not Cooling or Heating Well .....	23
16.4 This is Not Abnormal.....	23

# 1. Safety Summary

### DANGER

- Do not perform the installation work, refrigerant piping work, drain pump, drain piping and electrical wiring connection without referring to our installation manual. If the instructions are not followed, it may result in a water leakage, electric shock or a fire.
- Do not pour water into the indoor unit or outdoor unit. This product contains electrical components and if wet, can cause serious electrical shock.
- Do not open the service cover or access panel for the indoor or outdoor unit without turning OFF the main power supply.
- Do not touch or adjust safety devices inside the indoor unit or outdoor unit. If these devices are touched or readjusted, it may cause a serious accident.
- Refrigerant leakage can cause difficulty with breathing due to insufficient air. Turn OFF the main switch, extinguish any naked flames and contact your service contractor, if refrigerant leakage occurs.
- The installer and system specialist shall ensure safety against refrigerant leakage according to local regulations or standards.
- Use the ELB which is above medium reaction speed (residual-current circuit breaker, action time of 0.1s or less). Otherwise, it may lead to electric shock or fire.
- For installation, firmly connect the refrigerant pipe before the compressor starts operating. For maintenance, relocation and disposal, remove the refrigerant pipe after the compressor stops.
- Do not perform a short-circuit of the protection device such as the pressure switch when operating. It may cause a fire and explosion.

### WARNING

- Do not use any sprays such as an insecticide, lacquer, hair spray or other flammable gases within approximately 1 meter from the system.
- If the circuit breaker or fuse is often activated, stop the system and contact your service contractor.
- Check that the ground wire is securely connected. If the unit is not correctly grounded, it leads electric shock. Do not connect the ground wiring to a gas piping, water piping, lighting conductor or ground wiring for telephone.
- Connect a fuse of specified capacity.
- Before performing any brazing work, check to ensure that there is no flammable material around. When using the refrigerant be sure to wear leather gloves to prevent cold injuries.
- Fix the cables securely. External forces on the terminals could lead to a fire.
- Ensure that the wiring terminals are tightened securely with the specified torques. If not, generating fire or an electric shock at the terminal connection part may occur.

### CAUTION

- Do not step or put any material on the product.
- Do not put any foreign material on the unit or inside the unit.
- Provide a strong and correct foundation so that:

- (a) The outdoor unit is not on an incline.
- (b) Abnormal sound does not occur.
- (c) The outdoor unit will not fall down due to a strong wind or earthquake.

### NOTICE

- Make sure that the outdoor unit is not covered with snow or ice, before operation.
- In some cases, the packaged air conditioner may not be operated normally under the following cases.
  - \* In case that electrical power for the packaged air conditioner is supplied from the same power transformer as the device\*.
  - \* In case that the power source wires for the device\* and the packaged air conditioner are located close to each other.

Device\*: (Ex) Lift, container crane, rectifier for electric railway, inverter power device, arc furnace, electric furnace, large-sized induction motor and large-sized switch. It consumes a large quantity of electrical power.

Regarding the cases mentioned above, surge voltage may be inducted in the power supply wiring for the packaged air conditioner due to a rapid change in power consumption of the device and an activation of switch.

Therefore, check the field regulations and standards before performing electrical work in order to protect the power supply for the packaged air conditioner.

- If the supply cord is damaged, it must be replaced by the manufacturer, its service agent or similarly qualified persons in order to avoid a hazard.
- Means for disconnection from the supply mains, which have a contact separation in all poles that provide full disconnection under overvoltage category III conditions, must be incorporated in the fixed wiring in accordance with the AS/NZS 3000.
- The appliance shall be installed in accordance with relevant local and national wiring regulations.

### NOTE:

- It is recommended that the room will be ventilated every 3 to 4 hours.

## 2. Structure

## 2. Structure

### 2.1 Name of Parts

< PPIH-3.0UFA1NQ - PPIH-6.5UFA1NQ >

Unit: mm

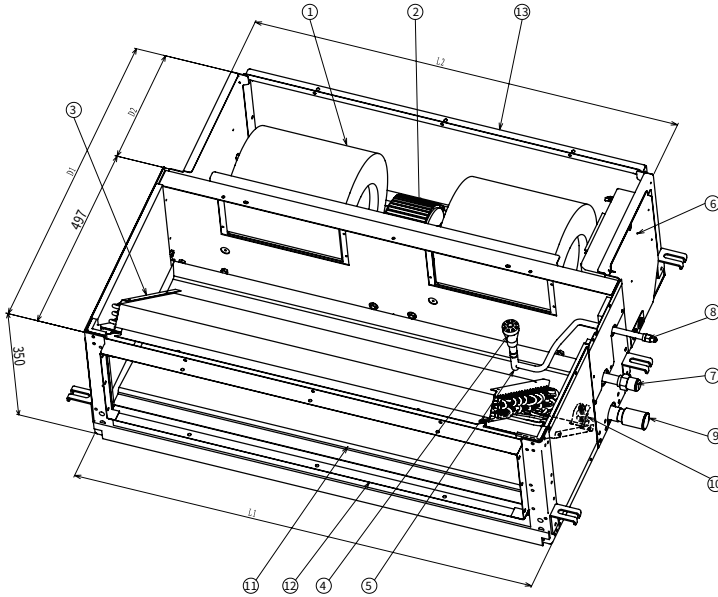

No.	Part Name
1	Fan
2	Fan Motor
3	Heat Exchanger
4	Distributor
5	Strainer
6	Electrical Control Box
7	Refrigerant Gas Pipe Connection
8	Refrigerant Liquid Pipe Connection
9	Drain Pipe Connection
10	Float Switch
11	Drain Pan
12	Air-discharge Outlet
13	Air-return Inlet

Model	L1	L2	D1	D2
PPIH-3.0UFA1NQ	1,076	1,000	800	303
PPIH-4.0UFA1NQ	1,076	1,000	800	303
PPIH-5.0UFA1NQ	1,300	1,240	890	393
PPIH-6.0UFA1NQ	1,300	1,240	890	393
PPIH-6.5UFA1NQ	1,300	1,240	890	393

Flange Dimension (H x W, mm)

Model	Air-return Inlet	Air-discharge Outlet
PPIH-3.0UFA1NQ	308 x 934	222 x 980
PPIH-4.0UFA1NQ		
PPIH-5.0UFA1NQ	308 x 1135	222 x 1204
PPIH-6.0UFA1NQ		
PPIH-6.5UFA1NQ		



## 2.2 Necessary Tools and Instrument List for Installation

No.	Tool	No.	Tool	No.	Tool
1	Handsaw	8	Plier	16	Cutter for Wires
2	Phillips Screwdriver	9	Pipe Cutter	17	Gas Leak Detector
3	Vacuum Pump	10	Brazing Kit	18	Leveler
4	Refrigerant Gas Hose	11	Hexagon Wrench	19	Clamper for Solderless Terminals
5	Megohmmeter	12	Spanner	20	Hoist (for Indoor Unit)
6	Copper Pipe Bender	13	Weigher	21	Ammeter
7	Manual Water Pump (for Indoor Unit)	14	Charging Cylinder	22	Voltage Meter
		15	Gauge Manifold	23	Wrench

### NOTE:

- About vacuum pump, gas hose, charging cylinder, gauge manifold, please use suitable equipments for R32 respectively. Do not mix other refrigerant.

## 3. Transportation and Handling

### 3.1 Transportation

Transport the product as close to the installation location as possible before unpacking.



- The maximum number of pieces of equipment or the configuration of the equipment permitted to be transported together will be determined by the applicable local transport regulations.



- Do not put any material on the product.

### 3.2 Handling of Indoor Unit



- Do not put any foreign material into the indoor unit and check to ensure that none exists in the indoor unit before the installation and test run. Otherwise, a fire or failure, etc. may occur.



- Be careful not to damage on insulation materials of unit's surface when lifting.

## 4. Indoor Unit Installation

**⚠ DANGER**

- Do not install the indoor unit in a flammable environment to avoid fire or an explosion.
- Do not install the indoor unit in the laundry.
- The indoor unit should be positioned in a place where:
  - (1) both the air inlet and air outlet are unobstructed,
  - (2) the unit is not exposed to direct sunlight,
  - (3) drainage occurs easily,
  - (4) the unit is away from sources of heat or steam,
  - (5) there is no source of machine oil vapor (this may shorten the indoor unit service life),
  - (6) cool/warm air is circulated throughout the room,
  - (7) the unit is away from electronic ignition type fluorescent lamps (inverter or rapid start type) as they may affect the remote controller range,

**⚠ WARNING**

- Check to ensure that the ceiling slab is strong enough. If not strong enough, the indoor unit may fall down on you.
- Do not install the indoor unit outdoors. If installed outdoors, an electric hazard or electric leakage will occur.
- Indoor units should be installed higher than 2.5 meters from the floor level.







### 4.1 Factory-Supplied Accessories

Check to ensure that the following accessories are packed with the indoor unit.

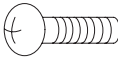
**NOTE:**

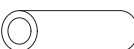
- If any of these accessories are not packed with the unit, please contact your contractor.

Table 4.1 Factory-Supplied Accessories

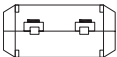
Accessory	Q'ty	Purpose
Screw 	16	For Fixing Flanges
Hose Clamp 	1	For Drain Hose Connection
Insulation (22 ID x 130) 	1	For Refrigerant Liquid Piping
Insulation (40 ID x 130) 	1	For Refrigerant Gas Piping
Cord Clamp 	5	For Fixing Thermal Insulation for Refrigerant Pipings
Cord Clamp 	6	
Magnet Ring 	1	For anti-electromagnetic interference of transmission wires between outdoor and indoor units

## 4.2 Initial Check

- Install the indoor unit with a proper clearance around it for operation and maintenance working space, as shown in Fig.4.1.

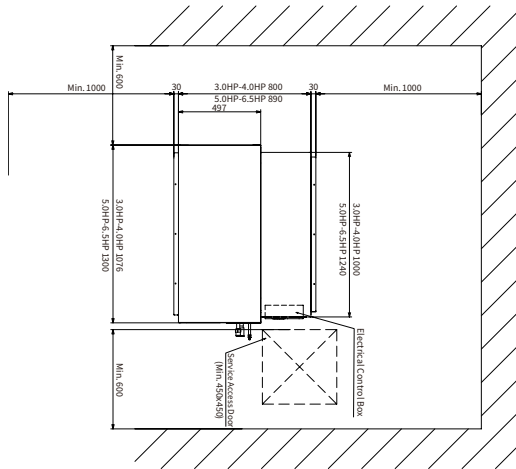

Unit: mm

\* In case that the ceiling board can not be detected for servicing, prepare a service access door below the indoor unit for removing the indoor unit.

Fig.4.1 Operation and Installation Space

- Consider the air distribution from the indoor unit to the space of the room, and select a suitable location so that uniform air temperature in the room can be obtained.
- Do not install flammable parts in the service space for the indoor unit.
- Avoid obstacles which may hamper the air intake or the air discharge flow.
- Do not install the indoor unit in a machine shop or kitchen where vapor from oil or its mist flows to the indoor unit.

The oil will deposit on the heat exchanger, thereby reducing the indoor unit performance, and may deform and in the worst case, break the plastic parts of the indoor unit.

- Pay attention to the following points when the indoor unit is installed in a hospital or other facilities where there are electronic waves from medical equipment.
  - Do not install the indoor unit where the electromagnetic wave is directly radiated to the electrical box, remote control cable or remote control switch.
  - Install the indoor unit and components as far as practical or at least 3 meters from the electromagnetic wave radiator.
  - Prepare a steel box and install the remote control switch in it. Prepare a steel conduit tube and wire the remote control cable in it. Then, connect the ground wire with the box and the tube.
  - Install a noise filter when the power supply emits harmful noises.
- To avoid any corrosive action to the heat exchangers, do not install the indoor unit in an acid or alkaline environment.

## 4.3 Installation

### 4.3.1 Mounting on Truss

In the case that the indoor unit is installed in the false ceiling space without hanging, pay attention to the following items.

## 4. Indoor Unit Installation

(1) Apply vibration absorbing mats (10t) under the indoor unit.

< PPIH-3.0UFA1NQ - PPIH-6.5UFA1NQ >

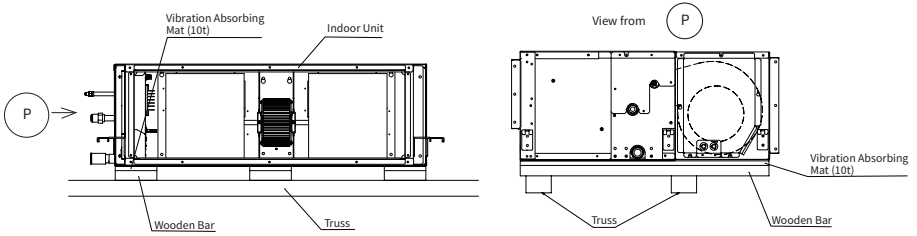

Place the three wooden bars on the truss as shown in the figure.

Note that the middle wooden bar should be placed in the center position of the unit.

(2) Apply an auxiliary drain under the indoor unit if the ambient humidity is higher than 80% (RH).

### 4.3.2 Separating Indoor Unit (If required)

**NOTE:**

- Separate the indoor unit only when necessary. Disassemble and reassemble on a flat surface.

< PPIH-3.0UFA1NQ - PPIH-4.0UFA1NQ >

Separate the indoor unit in the following order.

(1) Remove the E-BOX cover (2 screws) (Fig.4.2).

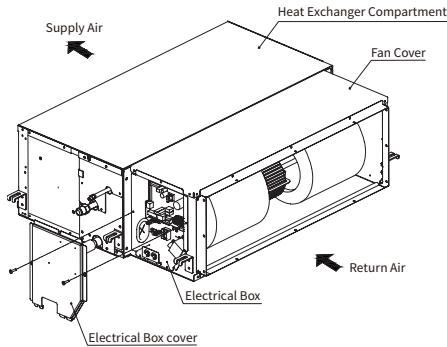

Fig.4.2

(2) Unplug the float switch, temperature sensor. After removing the insulation tape (store for reuse), unplug fan motor connectors as below, and unfasten fan motor wiring (Fig.4.3).

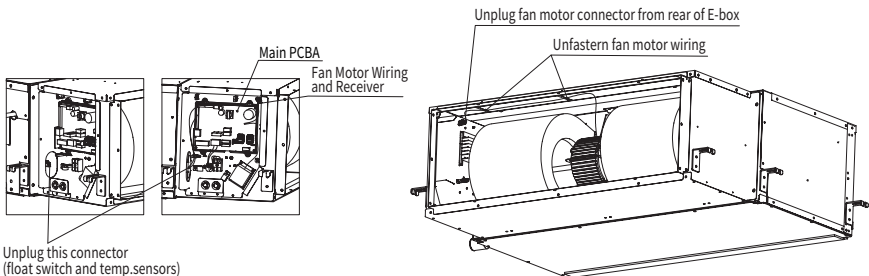

Fig.4.3

- (3) Remove the 4 bolts (M6) on the back of the supply air box, carefully pull the Return Air Box away, taking care not to damage the fan motor wiring (Fig.4.4).

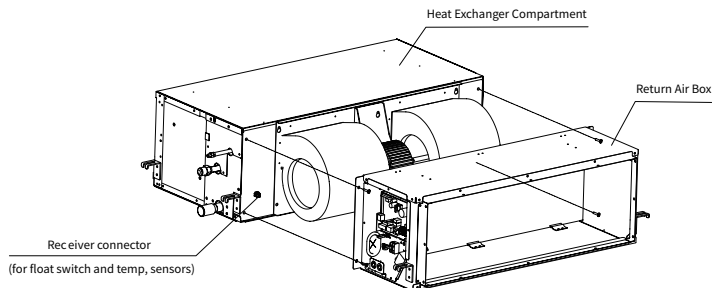

Fig.4.4

- (4) Remove the 5 bolts (M6) securing the fan assembly to the heat exchanger compartment. The fan assembly will be lifted off (Fig.4.5).

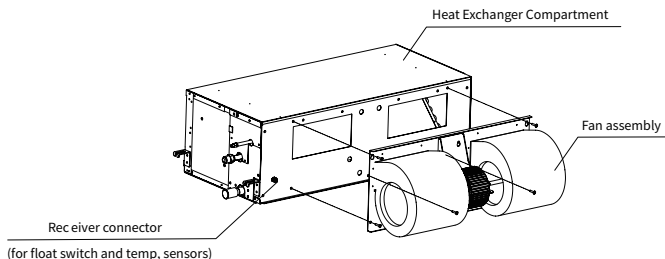

Fig.4.5

Rejoin the return air and supply air compartments in the following order.

- (5) Carefully place the fan assembly back into the original position.
- (6) Fix the fan assembly onto the heat exchanger compartment with 5 bolts (M6).
- (7) Carefully replace the Return Air Box, taking care not to damage the fan motor wiring, and fix the Return Air Box with the 4 bolts (M6).
- (8) Reconnect the float switch, temperature sensor. Reconnect fan motor plugs, wrapped and tightened with insulation tape, and tie fan motor wiring.

< PPIH-5.0UFA1NQ - PPIH-6.5UFA1NQ >

Separate the indoor unit in the following order.

- (1) After removing the insulation tapes(store for reuse), unplug the float switch and temperature sensor connector, fan motor connectors from the Return Air Box as below; Unfasten fan motor wiring (Fig.4.6).

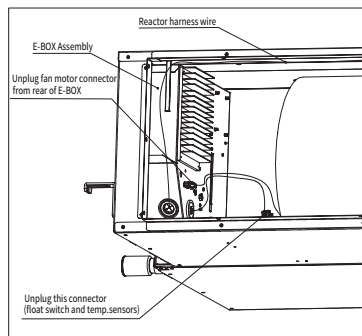

Fig.4.6

## 4. Indoor Unit Installation

- (2) Remove the 4 bolts (M6) on the back of the supply air box, carefully pull the Return Air Box away, taking care not to damage the fan motor wiring (Fig.4.7).

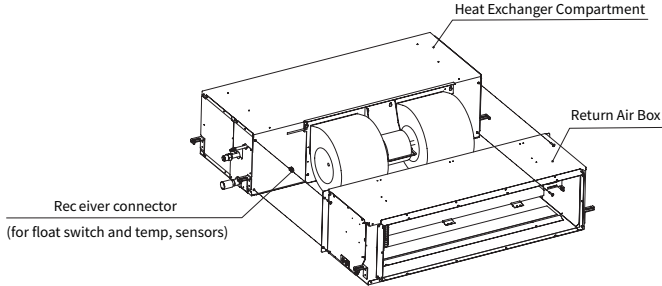

Fig.4.7

- (3) Remove the 7 bolts (M6) on the back of the supply air box, carefully pull the fan cover away, taking care not to damage the fan motor wiring (Fig.4.8).

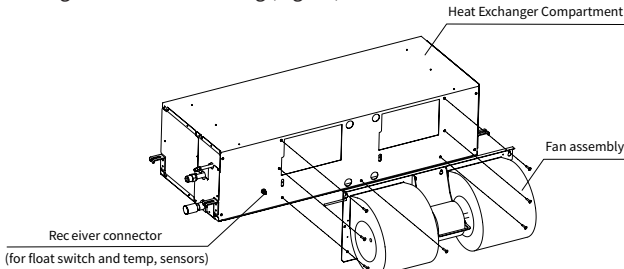

Fig.4.8

Rejoin the return air and supply air compartments in the following order.

- (4) Carefully place the fan assembly back into the original position.
- (5) Fix the fan assembly onto the heat exchanger compartment with 7 bolts (M6).
- (6) Carefully replace the Return Air Box, taking care not to damage the fan motor wiring, and fix the Return Air Box with the 5 bolts (M6).
- (7) Reconnect the float switch and temperature sensor, fan motor connector, wrapped and tightened with insulation tapes, and tie fan motor wiring.

### 4.3.3 Mounting on Suspension Brackets (Field-Supplied)

Mount the suspension brackets to the suspension bolts and secure them with nuts as shown. Use (field-supplied) angle and threaded rods, M10 or greater are also recommended to brace the unit mounting. (Check with local and national building codes and or a structural engineer as to the fixing of the unit or building support structure if applicable.)

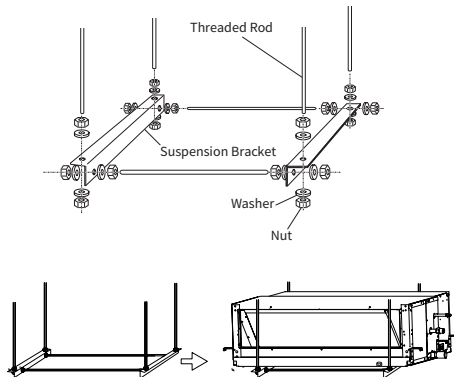

### 4.3.4 Suspension Bolts

#### Step1

Select final location and installation direction of the indoor unit paying careful attention to the space for the piping, wiring and maintenance.

#### Step2

Mount suspension bolts, as shown in Fig.4.9.

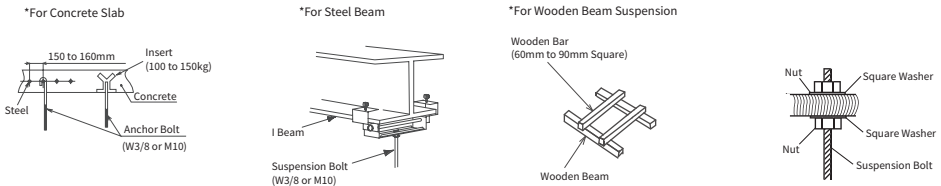

Fig.4.9 Mounting of Suspension Bolts

### 4.3.5 Marking of the Positions of the Sling Bolts and Piping Connections

- (1) Mark the positions of the sling bolts, refrigerant piping connections and drain connection.
- (2) Installation dimensions are shown in Fig.4.10.

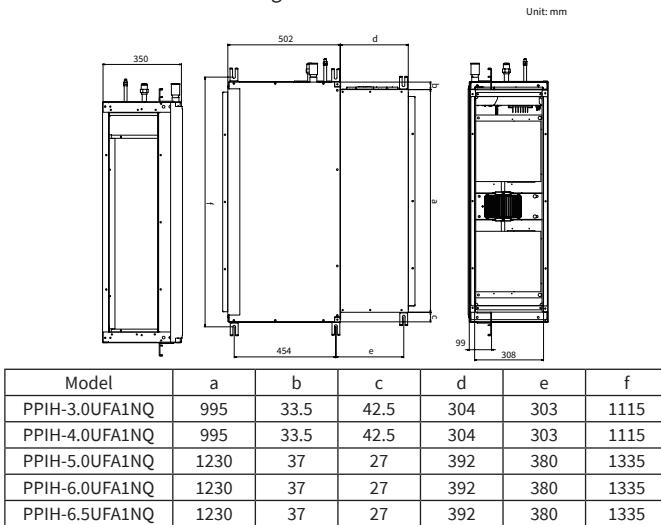

Fig.4.10 Suspension Bolts

### 4.3.6 Mounting of the Indoor Unit

Hang the indoor unit as shown in Fig.4.11.

- Field-Supplied Parts  
 \*Sling Bolts 4-M10 or W3/8  
 \*Nut 8-M10 or W3/8

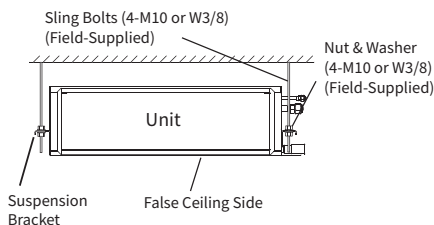

Fig.4.11 Hanging Indoor Unit

## 4. Indoor Unit Installation

### (1) How to put Nuts or Sling Bolts

Put nuts on each of the four hanging bolts, as shown in Fig.4.12.

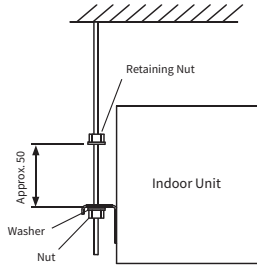

Fig.4.12 Sling Bolts and Nut

### (2) Hanging the Indoor Unit

- \* Hook suspension bracket to the nut and washer of each hanging bolt, as shown, starting at the opposite side to service cover side.
- \* After checking that the nut and washer are correctly fixed by the retainers of the suspension bracket of the service cover side to the nut and washer. (Put the sling bolts away from the unit when hooking)

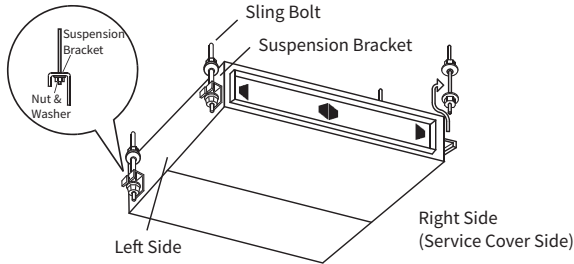

Fig.4.13 Hanging Indoor Unit

### 4.3.7 Adjusting of Unit Level

(1) Check to ensure that the foundation is flat, taking into account the maximum foundation gradient.

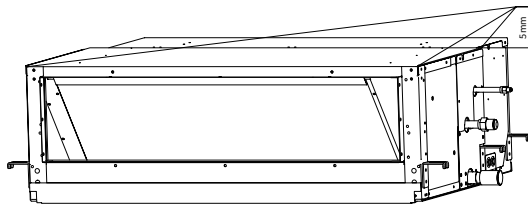

Fig.4.14 Foundation Gradient

(2) The unit should be installed so that the rear side of the unit is slightly (0mm to 5mm) lower than the front side, in order to avoid the incorrect position of the drain discharge.

#### NOTE:

- Keep the unit as well as relevant equipment covered with the vinyl cover during installation work.

### 4.3.8 Connecting Supply Duct

- (1) The supply duct should be connected with the indoor unit through canvas ducts, in order to avoid abnormal sound vibration (Refer to Fig.4.15). The unit is equipped with a pre-drilled duct flange for the supply duct connection.
- (2) Attach the vibration proof rubber to Sling Bolt in order to avoid abnormal sound vibration.
- (3) Duct material should be non-flammable material.



(4) Perform the heat insulation work over the duct for dew protection.

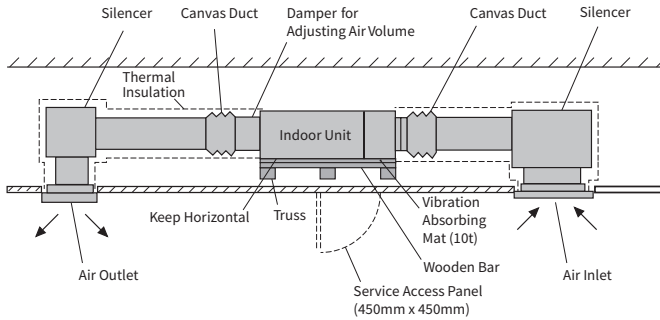

Fig.4.15 Duct Connection

### ⚠ CAUTION

- This duct unit return air outside need to be connected 1 meter duct at least in field.
- Ducted IDU machine must be connected with the return air duct, direct inhalation of high temperature air in the attic is prohibited.
- If a lower sound level is further required, install silencer (field-supplied).
- Design duct arrangement as “Unit External Static Pressure=Pressure Drop of Duct+Pressure Drop of Air Outlet and Air Inlet”. If duct design is not appropriate, big sound and splash will occur.
- Before unit starting up, use wired remote controller to operate auto ESP function or ensure the setting ESP is almost same with field duct pressure. If are not appropriate, big sound and splash will occur.

### 4.3.9 Setting of External Static Pressure

Refer to “7.5 Setting of External Static Pressure”.

## 5. Refrigerant Piping Work

### ⚠ DANGER

- Use refrigerant R32 in the refrigerant cycle. Do not charge oxygen, acetylene or other flammable and poisonous gases into the refrigerant cycle when performing a leakage test or an air-tight test. These types of gases are extremely dangerous and cause an explosion. It is recommended that dry nitrogen be used for these types of tests.

### 5.1 Piping Materials

- (1) Prepare locally-supplied copper pipes.
- (2) Select clean copper tubes making sure there is no dust and moisture inside the tubes. Before connecting pipes, blow the inside of the tubes with nitrogen or dry air, to remove any dust or foreign materials.

### 5.2 Piping Connection

#### ⚠ CAUTION

- Cap the end of the pipe when the pipe is to be inserted through a hole.
- Do not put pipes on the ground directly without a cap or vinyl tape at the end of the pipe.

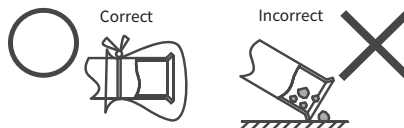

- An excess or a shortage of refrigerant is the main cause of trouble to the units. Charge the correct refrigerant quantity.

## 5. Refrigerant Piping Work

(1) Position of piping connection is shown below.

Unit: mm

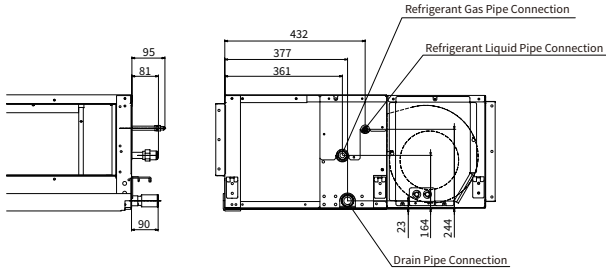
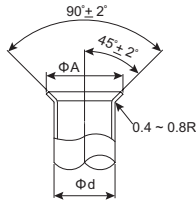

Fig.5.1 Position of Piping Connection

Unit: mm (in.)

Model	Gas Piping	Liquid Piping
PPIH-3.0UFA1NQ	Φ12.7(1/2)	Φ6.35(1/4)
PPIH-4.0UFA1NQ	Φ15.88(5/8)	Φ9.53(3/8)
PPIH-5.0UFA1NQ		
PPIH-6.0UFA1NQ		
PPIH-6.5UFA1NQ		

Perform the flaring work as shown below.



Unit: mm (in.)

Diameter Ød	A <sup>+0</sup> <sub>-0.4</sub>
	R32
Ø6.35(1/4)	9.1
Ø9.53(3/8)	13.2
Ø12.7(1/2)	16.6
Ø15.88(5/8)	19.7

(2) When tightening the flare nut, use two spanners as shown in Fig.5.2.

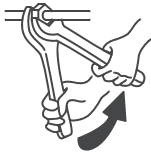

Pipe Size (mm (in.))	Tightening Torque (N·m)
Φ6.35mm(1/4)	20
Φ9.53mm(3/8)	40
Φ12.7mm(1/2)	80
Φ15.88mm(5/8)	100

Fig.5.2 Tightening Work of Flare Nut

(3) After connecting the refrigerant piping, seal the refrigerant pipes by using the factory-supplied insulation material as shown in Fig.5.3.

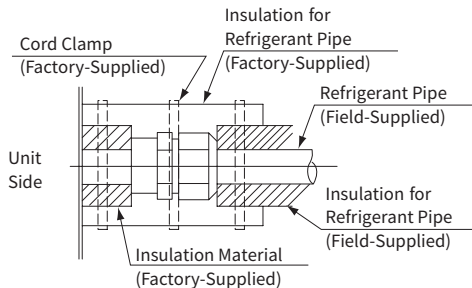

Fig.5.3 Insulation on Pipes

- (4) Evacuation and refrigerant charging procedures should be performed according to “Installation & Maintenance Manual” of the outdoor unit.

### 6. Drain Piping

- (1) The position of the drain piping connection is shown in Fig.6.1.
- (2) Prepare polyvinyl chloride pipe with a 32mm outer diameter.
- (3) Fasten the tube to the drain hose with the adhesive agent and the factory-supplied clamp. The drain piping must be performed with a DOWN-SLOPE pitch of 1/25 to 1/100.
- (4) Insulate the drain pipe after connecting the drain hose.

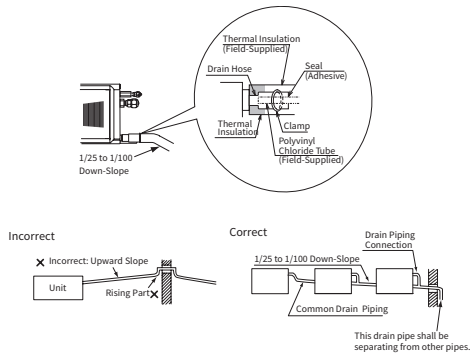

Fig.6.1 Drain Piping

#### NOTE:

- When the relative humidity of inlet or ambient air exceeds 80%, apply an (field-supplied) auxiliary drain pan beneath the indoor unit as shown in Fig.6.2.

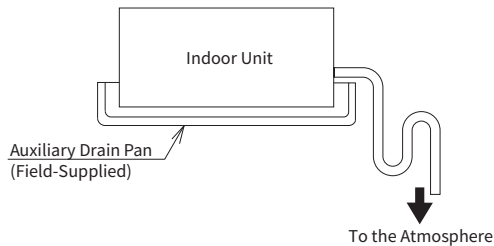

Fig.6.2 Auxiliary Drain Pan

- (1) Do not create an upper-slope or rise for the drain piping, since drain water can flow back to the unit and leakage to the room will occur when the unit operation is stopped.
- (2) Do not connect the drain pipe with sanitary or sewage piping or any other drainage piping.
- (3) When the common drain piping is connected with other indoor units, the connected position of each indoor unit must be higher than the common piping. The pipe size of the common drain pipe must be large enough according to the unit size and number of units.
- (4) After performing drain piping work and electrical wiring, check to ensure that water flows smoothly as in the following procedure.
- (5) Checking with the Float Switch.
  - (a) Switch ON the power supply.
  - (b) Pour 2 or 2.5 liters of water into the drain pan.
  - (c) Check to ensure that the water flows smoothly or whether water leakage occurs. When water cannot be found at the end of the drain piping, pour another 2 liters of water into the drain.

# 7. Electrical Wiring

### ⚠ WARNING

- Turn OFF the main power switch of the indoor unit and the outdoor unit and wait for more than 10 minutes before electrical wiring work or a periodical check is performed.
- Check to ensure that the indoor fan and the outdoor fan have stopped before electrical wiring work or a periodical check is performed.
- Protect the wires, drain pipe, electrical parts, etc. from rats or other small animals. Otherwise, rats may gnaw at unprotected parts and at the worst, a fire will occur.
- Tighten screws according to the following torque.  
M3.5 : 1.2 N·m  
M5 : 2.0 to 2.4 N·m
- The ground wire must be longer than the current-carrying conductor when installing the power cord.
- Using the air conditioner power terminal to transfer the power cord is strictly prohibited. A power distribution box can be used to expand the power distribution on the indoor unit.

### ⚠ CAUTION

- Wrap the accessory packing around the wires, and plug the wiring connection hole with the seal material to protect the product from any condensate water or insects.
- Tightly secure the wires with the cord clamp inside the indoor unit.
- Secure the cable of the remote control switch using the cord clamp inside the electrical box.

## 7.1 General Check

- (1) Make sure that the field-selected electrical components (main power switches, circuit breakers, wires, conduit connectors and wire terminals) have been properly selected according to the electrical data given in “Technical Catalog”. Make sure that the components comply with National Electrical Code (NEC).
- (2) Check to ensure that the power supply voltage is within  $\pm 10\%$  of the rated voltage.
- (3) Check the capacity of the electrical wires. If the power source capacity is too low, the system cannot be started due to the voltage drop.
- (4) Check to ensure that the ground wire is connected.
- (5) Power Source Main Switch  
Install a multi-pole main switch with a space of 3.5mm or more between each phase.

## 7.2 Electrical Wiring Connection

The electrical wiring connection for the indoor unit is shown in Fig.7.1 (for 3.0 - 4.0HP models) or Fig.7.2 (for 5.0 - 6.5HP models).

- (1) Connect the cable of an optional remote control switch or an optional extension cable to the connectors on the printed circuit board inside the electrical box through the connecting hole in the cabinet.
- (2) Connect the power supply and earth wires to the terminals in the electrical box.
- (3) Connect the wires between the indoor unit and the outdoor unit to the terminals in the electrical box.
- (4) Tightly clamp the wires using the cord clamp inside the electrical box.

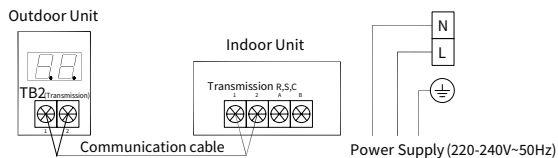

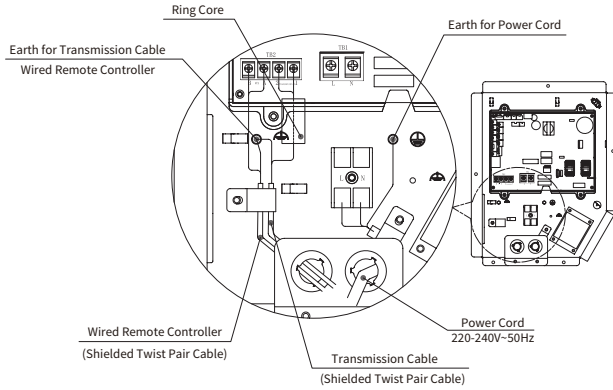
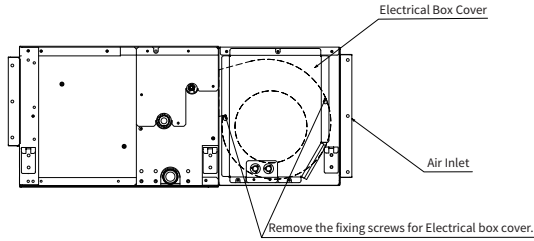

Fig.7.1 Electrical Wiring Connection (Only for 3.0 - 4.0HP Models)

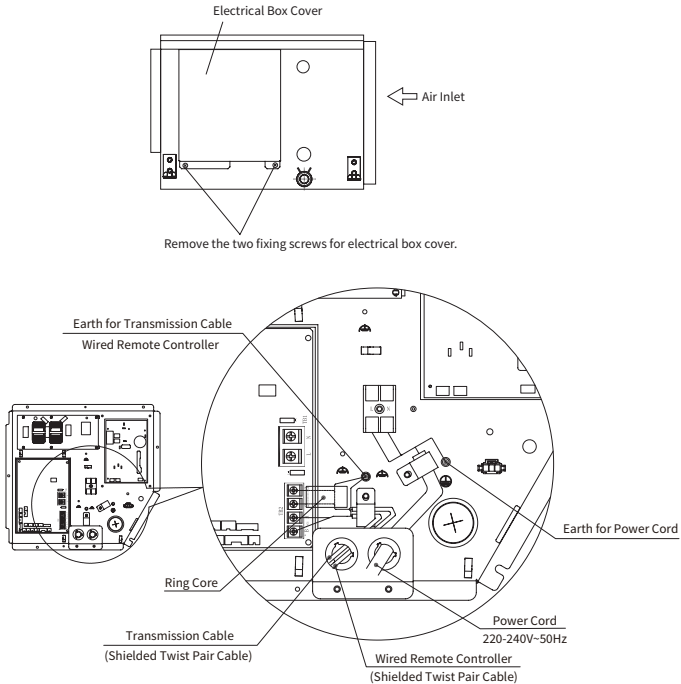

Fig.7.2 Electrical Wiring Connection (Only for 5.0 - 6.5HP Models)

## 7. Electrical Wiring

### NOTE:

- The ring core needs to be installed on the transmission cable between the fixed wire clamp and TB2, where additional insulation rubber is peeled off.

### [Procedure]

Insert the transmission cable into the ring core as shown in the right figure before connecting to the terminal board. Fix the cable and the ring core by using the band (accessory) in the electrical box.

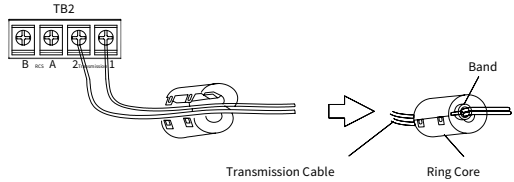

## 7.3 Field Minimum Wire Sizes for Power Source

- Use an ELB (Electric Leakage Breaker). If not used, it will cause an electric shock or a fire.
- Do not operate the system until all the check points have been cleared.
  - Check to ensure that the electrical resistance is more than 1 megohm, by measuring the resistance between ground and the terminal of the electrical parts. If not, do not operate the system until the electrical leakage is found and repaired.
  - Check to ensure that the stop valves of the outdoor unit are fully opened, and then start the system.
  - Check to ensure that the switch on the main power source has been ON for more than 12 hours, to warm the compressor oil by the crankcase heater.
- Pay attention to the following items while the system is running.
  - Do not touch any of the parts by hand at the discharge gas side, since the compressor chamber and the pipes at the discharge side are heated higher than 90°C.
  - DO NOT PUSH THE BUTTON OF THE MAGNETIC SWITCH(ES). It will cause a serious accident.

Model	Power Source	Maximum Current(A)	Power Source Cable Size		Transmitting Cable Size	
			IEC 60335-1 *1	MLFC *2	IEC 60335-1 *1	MLFC *2
PPIH-3.0UFA1NQ	220-240V~50Hz	3.81	2.5mm <sup>2</sup>	2.5mm <sup>2</sup>	0.75mm <sup>2</sup>	0.75mm <sup>2</sup>
PPIH-4.0UFA1NQ		5.11				
PPIH-5.0UFA1NQ		5.04				
PPIH-6.0UFA1NQ		5.37				
PPIH-6.5UFA1NQ		6.26				

### NOTES:

- Follow local codes and regulations when selecting field wires.
- The wire sizes marked with \*1 in the table are selected at the maximum current of the unit according to the European Standard, IEC 60335-1. Use the wires which are not lighter than the ordinary tough rubber sheathed flexible cord (code designation H05RR-F) or ordinary polychloroprene sheathed flexible cord (code designation H05RN-F) when get power from outside.
- The wire sizes marked with \*2 in the table are selected at the maximum current of the unit according to the wire, MLFC (Flame Retardant Polyflex Wire) manufactured by Hitachi Cable Ltd., Japan.
- Use a shielded cable for the transmitting circuit and connect it to ground.
- In the case that power cables are connected in series, add each unit maximum current and select wires below.

Selection According to IEC 60335-1		Selection According to MLFC (at Cable Temperature of 60°C)	
Current i (A)	Wire Size (mm <sup>2</sup> )	Current i (A)	Wire Size (mm <sup>2</sup> )
$i \leq 6$	2.5	$2.5 < i \leq 6$	2.5
$6 < i \leq 10$	2.5	$6 < i \leq 10$	2.5
$10 < i \leq 16$	2.5	$10 < i \leq 16$	2.5
$16 < i \leq 25$	4	$16 < i \leq 25$	4
$25 < i \leq 32$	6	$25 < i \leq 32$	6
$32 < i \leq 40$	10	$32 < i \leq 40$	10
$40 < i \leq 63$	16	$40 < i \leq 63$	16
$63 < i$	*3		

\*3: In the case that current exceeds 63A, do not connect cables in series.

## 7.4 DIP Switch Setting

1. Turn OFF all the power supplies to both indoor and outdoor units before DIP switch setting. Otherwise, the setting is invalid.
2. The positions of the DIP switches on the PCB are shown in the figure right. Open the electrical box cover. After the DIP switches are set, attach the electrical box cover again.

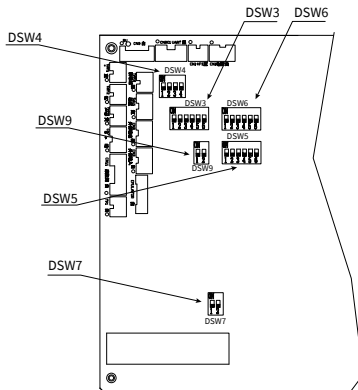

### 3. Unit number setting (DSW6)

The indoor unit numbers of all indoor units are not required. The indoor unit numbers are set by the auto-address function. If the indoor unit number setting is required, set the unit numbers. of all indoor units respectively and serially by the following setting position.

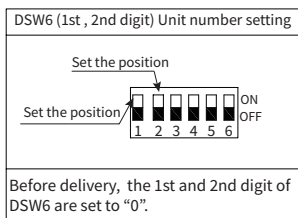

No.1 Unit	No.2 Unit	No.3 Unit	No.4 Unit
ON OFF ON OFF ON OFF ON OFF	ON OFF ON OFF ON OFF ON OFF	ON OFF ON OFF ON OFF ON OFF	ON OFF ON OFF ON OFF ON OFF
1 2 3 4 5 6	1 2 3 4 5 6	1 2 3 4 5 6	1 2 3 4 5 6

### 4. Region identification, human sensor and low air volume setting

DSW6 (4th digit), RSW1(Region Identification)

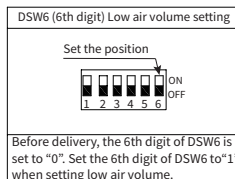
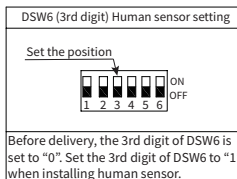
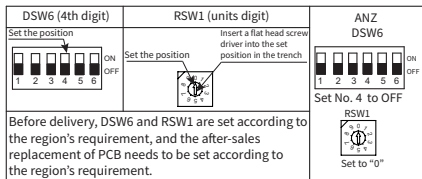

### 5. Capacity code setting (DSW3)

No setting is required as these have been preset at the factory at time of production. These switches have been set according to the capacity of the indoor unit.

3.0	4.0	5.0	6.0	6.5
ON OFF ON OFF ON OFF ON OFF ON OFF	ON OFF ON OFF ON OFF ON OFF ON OFF	ON OFF ON OFF ON OFF ON OFF ON OFF	ON OFF ON OFF ON OFF ON OFF ON OFF	ON OFF ON OFF ON OFF ON OFF ON OFF
1 2 3 4 5 6	1 2 3 4 5 6	1 2 3 4 5 6	1 2 3 4 5 6	1 2 3 4 5 6

### 6. Unit type code setting (DSW4)

As this is already set before shipment, no setting is required. This switch is used for setting the unit type code which corresponds to the type of the indoor unit.

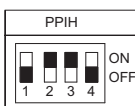

## 7. Electrical Wiring

### 7. Refrigerant cycle No. setting (DSW5)

These switches set the refrigerant cycle number and need to be made only when connecting multiple systems together via H-Link (e.g. central control)

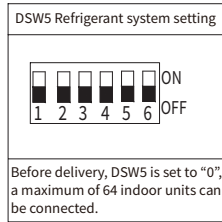

### 8. Fuse recover (DSW7)

\* No setting is required. Setting positions before shipment are all OFF.

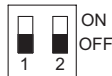

### NOTICE

- The "■" mark indicates the positions of DIP switches. The figures show settings before shipment.
- When the unit no. and the refrigerant cycle no. are set, record them to facilitate maintenance and servicing activities in the future.
- Turn OFF all the power supplies of the indoor and outdoor units before DIP switch setting. Otherwise, the setting is invalid.



## 7.5 Setting of External Static Pressure

- (1) This function is available for airCore 700 ducted indoor units, please refer to the "chapter25.ESP Setting" of Installation & Maintenance Manual of the wired remote controller for details.
- (2) The air flow volume can be changed according to the external static pressure by setting the item code to "C5" from the wired remote controller, please refer to the "chapter6.Function Selection" of Installation & Maintenance Manual of the wired remote controller for details.

Model	External Static Pressure	Setting of Wired remote controller
PPIH-3.0UFA1NQ	150Pa	00
	200Pa	01
	35Pa	02
PPIH-4.0UFA1NQ	150Pa	00
	200Pa	01
	50Pa	02
PPIH-5.0UFA1NQ PPIH-6.0UFA1NQ PPIH-6.5UFA1NQ	150Pa	00
	200Pa	01
	60Pa	02

## 8. Test Run

Test run should be performed according to "Installation & Maintenance Manual" of the outdoor unit or wired remote controller.

### WARNING

- Do not operate the system until all the check points have been cleared.
  - (a) Check to ensure that the electrical resistance is more than 1 megohm, by measuring the resistance between ground and the terminal of the electrical parts. If not, do not operate the system until the electrical leakage is found and repaired.
  - (b) Check to ensure that the stop valves of the outdoor unit are fully opened, and then start the system.
  - (c) Check to ensure that the switch on the main power source has been ON for more than 12 hours, to warm the compressor oil by the crankcase heater.
- Pay attention to the following items while the system is running.
  - (a) Do not touch any of the parts by hand at the discharge gas side, since the compressor chamber and the pipes at the discharge side are heated higher than 90°C.
  - (b) DO NOT PUSH THE BUTTON OF THE MAGNETIC SWITCH(ES). It will cause a serious accident.

## 9. Safety and Control Device Setting

Indoor Unit

Model		PPIH-(3.0-4.0)UFA1NQ	PPIH-(5.0-6.5)UFA1NQ
For Control Circuit Fuse Capacity	A	10	20
Freeze Protection Thermostat	Cut-Out	°C	0
	Cut-In	°C	14
Thermostat Differential	°C	2	

## 10. System Description

# 10. System Description

The heat pump air conditioner is designed to offer cooling, heating, dry and fan operations. These operation modes are controlled by the remote control switch (optional).

Table 10.1 Indoor Unit Type List

Indoor Unit Type	Nominal Capacity (HP)				
	3.0	4.0	5.0	6.0	6.5
High ESP Ducted Indoor Unit	○	○	○	○	○

○ : Available

## 11. Wired remote controller

Model: PC-ARFG2-Z

### Display Part

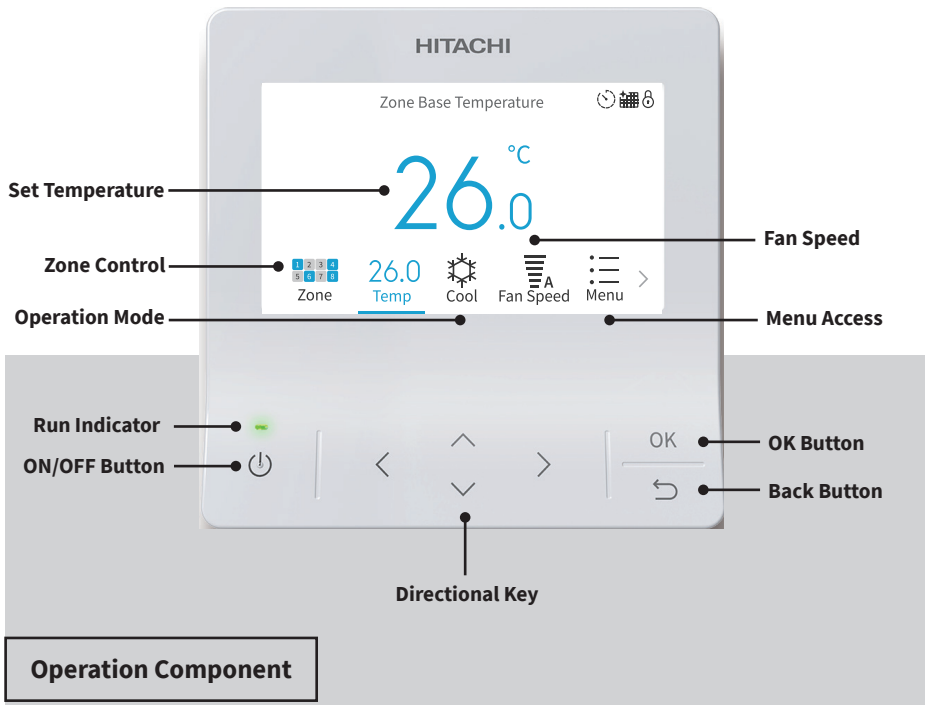

### Operation Component

#### NOTES:

- When the backlight turns off, user can press any button to turn on the backlight. (The button pressed to turn on the backlight is not functional.)
- Make sure to press the buttons lightly with your fingertips.
- Do NOT press the buttons or anything with sharp points, such as a ball point pen. The operational functionality of the controller may become damaged.

## 12. Before Operation



- Supply electrical power to the system for approximately 12 hours before start-up after long shut down. Do not start the system immediately after power supply, it may cause a compressor failure, because the compressor is not heated well.
  - Make sure that the outdoor unit is not covered with snow or ice. If covered, remove it by using hot water (approximately 50°C). If the water temperature is higher than 50°C, it will cause damage to plastic parts.
- When the system is started after a shutdown longer than approximately 3 months it is recommended that the system be checked by your service contractor.

Turn OFF the main switch when the system is stopped for a long period of time. If the main switch is not turned OFF, electricity is consumed, because the oil heater is always energized during compressor stopping.

## 13. Operation Method

Refer the manual for PC-ARFG2-Z.

## 14. Automatic Control

The system is equipped with the following functions.

### NOTE:

- Except for a long period of shutdown, keep the main power switch ON. The drain discharge mechanism is operated if the drain level is higher than the setting.

### Three Minute Guard (Enforced Stoppage)

The compressor remains off for at least 3 minutes once it has stopped. If the system is started within approximately 3 minutes after it has stopped, the RUN indicator is activated. However, the cooling operation or the heating operation remains off and does not start until after 3 minutes has elapsed.

### Three Minute Guard (Enforced Operation)

If all indoor units of the system are Thermo-OFF within approximately 3 minutes after compressor has started, compressor is operated during 3 minutes continuously. However, if all indoor units of the system are stopped by wired remote controller, compressor is stopped.

### Frost Prevention During Cooling Operation

When the indoor unit is operated at low discharge air temperature, the cooling operation may be changed to fan operation for a while to avoid frost formation on the indoor heat exchanger.

### Hot Start During Heating Operation

To prevent cold air discharge in the room, the fan speed is controlled from the slow position and the low position and then to the set position according to the discharge air temperature.

### Slow Air Control During Defrosting Operation

When the outdoor unit is performing the automatic defrosting operation, the indoor fan is stopped.

### Cooling of Indoor Unit

When the heating operation is stopped, the indoor fan operation is maintained at the slow position for the maximum of 2 minutes to lower temperature of the inside unit.

### Prevention of Overload Operation

When the indoor temperature is high during heating operation, compressor is stopped due to activation of the indoor thermistor until the temperature becomes low.

## 15. Filter Cleaning

---

### NOTE:

- If the system is stopped due to a power failure, it will not automatically start again although power is restored. In the event of a very brief power failure (2 seconds maximum), the settings are memorized. Therefore, the system starts automatically after approximately 3 minutes.

## 15. Filter Cleaning

Turn off the main power switch before taking out the filter.

The indication, “” is shown on the display of the wired remote controller after passing the time set on the wired remote controller. (Default Setting Time of PPIH: 1,200 hours)

After cleaning the air filter, perform filter sign reset according to the chapter of the wired remote controller PC-ARFG2-Z.

## 16. Troubleshooting



- When overflow of drain water from the indoor unit occurs, stop the operation and contact your contractor.
- When you smell or see white smoke coming from the unit, turn OFF the main power supply and contact your contractor.

### 16.1 If Trouble Still Remains

If the trouble still remains even after checking the following, contact your contractor and inform them of the following items.

- (1) Unit Model Name
- (2) Content of Trouble
- (3) Alarm Code No. on Liquid Crystal Display

### 16.2 No Operation

Check whether “TEMP” is set at the correct temperature.

### 16.3 Not Cooling or Heating Well

- Check for obstruction of air flow of the outside or inside units.
- Check if too much heat source exists in the room.
- Check if the air filter is clogged with dust.
- Check to see if the doors or windows are opened or not.
- Check if the temperature condition is not within the operation range.

### 16.4 This is Not Abnormal

#### • Smells from Indoor Unit

Smell adheres on indoor unit after a long period of time. Clean the air filter and panels or allow a good ventilation.

#### • Sound from Deforming Parts

During system starting or stopping, an abrading sound might be heard. However, this is due to thermal deformation of plastic parts. It is not abnormal.

#### • Steam from Outdoor Heat Exchanger

During defrosting operation, ice on the outdoor heat exchanger is melted, resulting in making steam.

- **Dew on Air Panel**

When the cooling operation continues for a long period of time under high humidity conditions (Higher than 27°C/80% R.H.), dew can form on the air panel.

- **Refrigerant Flow Sound**

While the system is being started or stopped, sound from the refrigerant flow may be heard.

NOTE:

- Except for a long period of shutdown, keep the main switch ON, since the oil heater is energized when the compressor is stopping.

# Memo

# Memo

## Packing List

Item	Q'ty
Indoor Unit	1
Operation Installation and Maintenance Manual	1
Screw	16
Hose Clamp	1
Insulation (22ID)	1
Insulation (43ID)	1
Cord Clamp (small)	5
Cord Clamp (big)	6
Magnet Ring	1



1184066

### Hitachi-Johnson Controls Air Conditioning, Inc.

Add.: 1-16-1, Kaigan Minato-ku, Tokyo, Japan

Specification in this catalogue are subject to change without notice, in order that Hitachi-Johnson Controls may bring the latest innovation to customers.