

Product Overview

1 September 2024

AIR CONDITIONING
WATER CONDITIONING
AIR DISTRIBUTION
VENTILATION & HEATING



Contact Us

DIRECTORY

SALES (Head Office)

Damon Clark 021-835 291
- Auckland Regional Sales Manager
Branka Volc 027-294 3300
- Key Account Manager
Bob Daw 021-528 118
- Account Manager
Grant Reynolds 0-27-704 7244
- Account Manager
John Lusty 09-279 5266
- Internal Sales Team Leader
Mike West 09-279 5263
- Engineering Estimator

TECHNICAL SUPPORT / WARRANTY

Hours 7.30 am – 5.00 pm 09-279-5251
Sean Christy
- Tz Technical Support Engineer
Ronald Serrato
- Hitachi Technical Support Engineer
Hardik Tanti
- Technical Support Engineer

ADMINISTRATION

Bryan Waters 09-279 5257
- National Sales Manager
Jamie Nankivell 09-279 5256
- Marketing Manager
Kylie Morey 09-277 3191 / 021-196 4648
- Customer Care Manager
Accounts Receivable 09-279 5254

SPARE PARTS / DESPATCH

Hours 7.30 am – 5.00 pm 09-279 5253

RECEPTION 09-279 5250
Facsimile 09-275 5637

HAMILTON BRANCH

Hours 8.00 am – 4.30 pm 04-569 3262
Graham Lawes 0-27-562 6452
- Account Manager (Hamilton)

WELLINGTON BRANCH

Hours 8.00 am – 4.30 pm 04-569 3262
Corbin Berriman 0-21-984 827
- Wellington Regional Manager
Craig Levien 0-21-558 758
- Account Manager
Mark Jury 021-454 0405
- Account Manager

CHRISTCHURCH BRANCH

Hours 8.00 am – 4.30 pm 03-379 3216
Tony Hansen 0-27-435 7203
- South Island Regional Manager
Craig Wiffen 0-27-433 0550
- Account Manager
Ian Kimpton 0-21-321 197
- Account Manager

EMAIL

..... nzsales@temperzone.com
..... customerservices@temperzone.com
..... nztechsupport@temperzone.com
..... nzspareparts@temperzone.com

AUCKLAND

38 Tidal Rd, Mangere South, 2022
Private Bag 93303, Otahuhu, 1640

Customer Services
Ph. 0800-TZWARRANTY
or 0-9-279 5251

HAMILTON

30 Gallagher Drive, Melville 3026
PO Box 15-058, Dinsdale 3243

Ph. 0-7-839 2705

WELLINGTON

6 Union Street,
Petone 5012

Sales Office
Ph. 0-4-569 3262

CHRISTCHURCH

40 Cass Street,
Sydenham 8023

Sales Office
Ph. 0-3-379 3216

WEBSITES

www.temperzone.com
www.temperzone.biz (Trade)
www.hitachiaircon.co.nz

<i>Content</i>	<i>Page</i>
Contact Us	2
Contents	3
Air Conditioning	
Split Systems - Ducted Reverse Cycle	4
Split Systems - Accessories	6
Controls	9
LOKRING	11
Packaged Units - Ducted Reverse Cycle	14
Packaged Systems – Accessories	17
Vertical Packaged Units - Ducted Reverse Cycle	18
Packaged Units - Ducted Water Cooled	19
Chilled Water Fan Coil Units	22
Chilled Water Air Handling Units	26
Heat Pump Water Heaters	27
Air Distribution	
Radial Swirl Diffusers	28
RPD - Round Plastic Ceiling Diffusers	29
Grilles	29
Adaptors for Grilles	29
Flexiduct, Duct Tape, Duct Joiners	30
Air Regulating Damper, Custom Grilles	31
Ventilation	
In-Line Centrifugal Fans	32
Other Products	
Circulating Water Pumps	33
Pre-Insulated Pipe	36

Hitachi – refer dedicated Temperzone Account Manager for a catalogue or visit www.hitachiaircon.co.nz

Split Systems - Ducted Reverse Cycle **R32**

These new systems are MEPS compliant, ie they meet the Minimum Energy Performance Standards set out in AS/NZS 3823.2:2013 and use refrigerant R32, which has a low GWP.

Each system includes a variable capacity inverter compressor – enabling close temperature control. Inverters provide additional economy at part load.

A wide range of unit sizes have been developed to meet the needs of any application, e.g. homes, apartments, offices, shop, restaurants, public and private areas of hotels, open plan office and work spaces, halls, hospitals and factories.

Filter box c/w filter available.

These ISD models are: separable (excl. 351), include high efficiency EC motors with optional 0-10V speed control, higher static performance, 12V control and include in-built safety drain tray. BMS/modbus compatibility is standard.



ITEM NO.	DESCRIPTION	UNIT	NOMINAL COOLING kW	NOMINAL HEATING kW
Single Phase:				
845-171-001	ISD 171LYX	Indoor	14.8	14.9
846-171-001	OSA 171RLSFH	Outdoor	(8.6~18.5)	(7.0~18.3)
Three Phase:				
845-171-001	ISD 171LYX	Indoor	14.8	14.9
846-171-003	OSA 171RLTFH	Outdoor	(8.6~18.5)	(7.0~18.3)
845-211-001	ISD 211LYX	Indoor	19.5	20.85
846-211-003	OSA 211RLTFH	Outdoor	(9.4~25.3)	(8.4~25.6)
845-251-001	ISD 251LYX	Indoor	23.3	23.3
846-251-003	OSA 251RLTFH	Outdoor	(13.3~29.5)	(10.4~29.2)
845-351-001	ISD 351LYX	Indoor	32.7	31.3
846-352-003	OSA 352RLTFV	Outdoor	(13.5~37.1)	(12.0~35.3)

Note:

ISD safety drain tray is built-in.
 Once separated, separable ISD units (up to 251) will fit through a clear aperture sized 550 mm sq. or more.
 Outdoor Unit complete with UC8 Controller, which is compatible with BMS/modbus
 Indoor Unit complete with IUC Controller.
 Room Temp. Controller can be direct connected to ISD indoor or OSA outdoor unit
 Outdoor unit is pre-charged with refrigerant for 15m (OSA 171–251) or 10m (OSA 352) of interconnecting pipe.

OPTIONS:

- SAT-3 Room Temperature Controller
 - 6 Zone Control Kit for use with SAT-3
 - TZT-100 Room Temperature Controller
 - ISD Filter Box c/w filter
 - ISD Supply & Return Air Plenums
 - ISD Spigot Plate adaptors (for unit separation)
 - ISD Spring Mounting Kit
 - OSA Louvre Guard Kit (OSA 171/211/251)
 - OSA 171/211/251 c/w Louvre Guards; made-to-order; POA
 - OSA Anti-vibration mounts
 - OSA Wall mounting kit (OSA 171/211)
- Refer to Accessories on page 8; Controls page 11.



LOUVRE GUARDS KIT
 (Supplied separately) :

244-002-308	for OSA 171
244-002-309	for OSA 211
244-002-310	for OSA 251

Nomenclature	
Suffixes:	
R	Reverse cycle system
L	Refrigerant R32
S	Single phase power supply
T	Three phase power supply
H	Horizontal discharge fans
V	Vertical discharge fans
Y	EC motor fan
F	Inverter compressor system
X	Includes IUC.

Split Systems - Ducted Reverse Cycle



These new systems are MEPS compliant, ie they meet the Minimum Energy Performance Standards set out in AS/NZS 3823.2:2013 and use refrigerant R410A.

A wide range of unit sizes have been developed to meet the needs of any application, e.g. homes, apartments, offices, shop, restaurants, public and private areas of hotels, open plan office and work spaces, halls, hospitals and factories.

These dual compressor systems enable staged capacity performance. Digital systems have a finer variable capacity ability for close control applications.

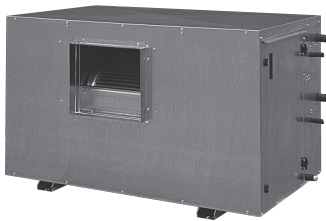

ITEM NO.	DESCRIPTION	UNIT	NOMINAL COOLING kW	NOMINAL HEATING kW
Dual Compressor Systems				
<u>Three Phase without Controls:</u>				
525-501-601	ISD 380KBY	Indoor	37.2	38.3
525-501-001	ISD 380KBH-P* EC Plug	Indoor	37.4	38.5
525-511-001	ISD 380KBV-P* EC Plug	Indoor	"	"
526-501-201	OSA 380RKTBV ⁽⁶⁾	Outdoor		
525-611-001	ISD 465KBH	Indoor	44.6	44.0
525-621-001	ISD 465KBV*	Indoor	"	"
526-651-201	OSA 465RKTBV ⁽⁶⁾	Outdoor		
525-591-201	ISD 570KBH	Indoor	56.1	55.9
525-591-211	ISD 570KBV*	Indoor		
525-601-201	ISD 570KBH-P* EC Plug	Indoor	56.6	53.4
525-601-211	ISD 570KBV-P* EC Plug	Indoor		
526-641-201	OSA 570RKTBV ⁽⁶⁾	Outdoor		
525-631-201	ISD 670KBH	Indoor	65.9	62.8
525-631-211	ISD 670KBV*	Indoor	"	"
525-641-201	ISD 670KBH-P* EC Plug	Indoor	65	62
525-641-211	ISD 670KBV-P* EC Plug	Indoor		
526-671-201	OSA 670RKTBV ⁽⁶⁾	Outdoor		
<u>Digital Compressor Systems</u>				
525-501-601	ISD 380KBY	Indoor	37.4	35.7
525-501-001	ISD 380KBH-P* EC Plug	Indoor	37.4	38.5
525-511-001	ISD 380KBV-P* EC Plug	Indoor	"	"
536-501-201	OSA 380RKTBGV ^{(6)*}	Outdoor		
525-661-223	ISD 840KBXH-P EC Plug	Indoor	84.6	78.3
525-671-201	ISD 840KBXV-P* EC Plug	Indoor	"	"
526-731-223	OSA 840RKTBGV ⁽⁶⁾	Outdoor		
525-701-201	ISD 950KBXH-P EC Plug	Indoor	93.0	90.4
525-711-201	ISD 950KBXV-P* EC Plug	Indoor	"	"
526-741-223	OSA 950RKTBGV ⁽⁶⁾	Outdoor		

Note:

* Not a stock item; made to order.

⁽⁶⁾ ⁽⁸⁾ Complete with UC6 or UC8 Controller, respectively.

Above models include 24V control.

Outdoor unit is precharged with refrigerant for 10m of interconnecting pipe.

OPTIONS:

Refer to Accessories pages 8–11.

Factory fitted options:

SAT-3 Controller, TZT-100 Controller, TZT-701 Controller, Electric Heat.

Digital compressor version (ie 1 digital + 1 fixed)

<p><i>Nomenclature</i></p> <p>Suffixes:</p> <p>K – Refrigerant R410A</p> <p>B – Twin system</p> <p>G – Digital compressor sys.</p> <p>H – Horizontal supply air</p> <p>P – Plug/EC motor</p> <p>V – Vertical supply air</p> <p>Y – EC motor</p>

Split Systems - Accessories

ITEM NO. DESCRIPTION

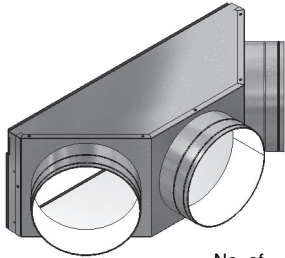

No. of inlets/outlets varies

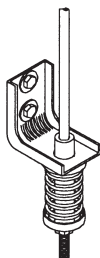
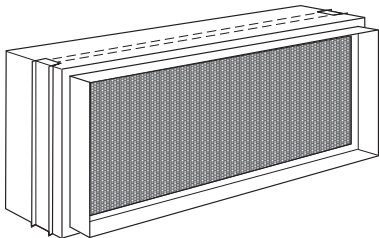
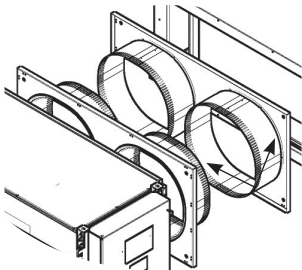
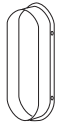
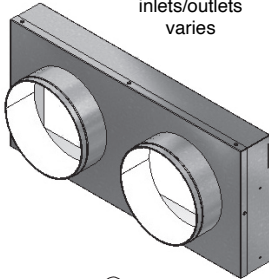

SUPPLY AIR PLENUMS (Round Spigots) :

- 492-000-004 for ISD 171LYX (2 x 400 dia.)
- 492-000-005 for ISD 211/251 LYX (3 x 400 dia.)
- 492-000-030 for ISD 351LYX (4 x 400 dia.)

RETURN AIR PLENUMS (Round Spigots) :

- 492-100-004 for ISD 171LYX (2 x 400 dia.)
- 492-100-005 for ISD 211LYX (2 x 400 dia.)
- 492-100-006 for ISD 251LYX (3 x 400 dia.)
- 492-100-008 for ISD 351LYX (4 x 400 dia.)

FRESH AIR INLET SPIGOTS (for R/A Plenums) :

- 325-000-051 for ISD 171/211 LYX (150 dia.)
- 325-000-052 for ISD 251/351 LYX (200 dia.)

SPIGOT PLATE ADAPTORS :

For rejoining gap between separable units (2 required)

- 525-271-705 for ISD 171LYX (Ø400 mm x 2)
 - 525-311-715 for ISD 211LYX (Ø450 mm x 2)
 - 525-311-715 for ISD 251LYX (Ø450 mm x 2)
- Refer page 40 for flexible ducting.

FILTER BOX c/w washable* synthetic fibre filter media (Supplied separately) :

- 493-000-004 for ISD 171LYX (EU2/G2 filter)
- 493-000-006 for ISD 211LYX (EU2/G2 filter)
- 493-000-007 for ISD 251LYX (EU4/G4 filter)
- 493-000-016 for ISD 351LYX (EU4/G4 filter)
- 525-501-605 for ISD 380KB(Y)(-P) (EU2/G2 filter)

* Except for EU4/G4 rated filters which are disposable

SPRING MOUNTING KIT :

- 307-161-101 for ISD 171-251LYX (No.2)
- 307-341-101 for ISD 351LYX, ISD 380KBY (No.3)

Split Systems - Accessories

ITEM NO.	DESCRIPTION
060-000-170	<u>ANTI-VIBRATION MOUNTS (Rubber) :</u> for OSA 171–352 Outdoor Units (set of 4)

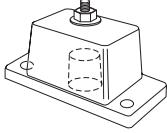

526-061-007	<u>WALL MOUNTING KIT :</u> Powder coated galv. steel (SWL 185kg) for OSA 171–211 (H)
-------------	--

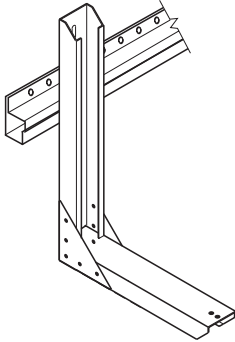

201-000-105	<u>FAULT INDICATOR (Supplied separately) :</u> Fault Indicating Auxiliary Relay Board
-------------	--

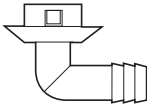

060-000-039	<u>DRAIN CONNECTION ADAPTOR (25/13mm) (Supplied separately) :</u> for OSA 171–352
-------------	--

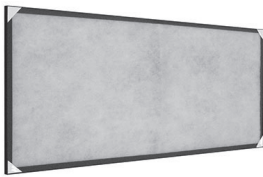

119-000-080	<u>REPLACEMENT FILTERS (EU2/G2 rated, washable synthetic fibre):</u> for ISD 171LYX
119-000-082	for ISD 211LYX

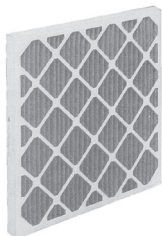

019-400-002	<u>REPLACEMENT FILTERS (EU4/G4 rated, disposable):</u> ISD 251LYX - 3 required in total 400 x 500 x 50 - 2 required
019-400-003	400 x 625 x 50 - 1 required.
019-400-003	ISD 351LYX 400 x 625 x 50 - 3 required

Split Systems - Accessories

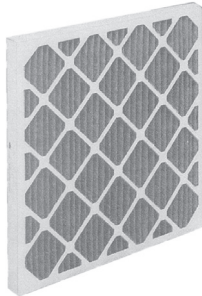

ITEM NOI. DESCRIPTION

FILTERS (Disposable, supplied separately) :

	ISD 465KB Filters (rated EU4) - 6 required in total:
019-400-008	450 x 500 x 50 - 3 required
019-400-010	450 x 600 x 50 - 3 required
	ISD 570/670KB Filters (rated EU4) - 6 required in total:
019-400-004	500 x 500 x 50 - 2 required
019-400-008	450 x 500 x 50 - 4 required
	ISD 840KB Filters (rated EU4) - 8 required in total:
019-400-004	500 x 500 x 50 - 4 required
019-400-008	450 x 500 x 50 - 4 required
	ISD 950KB Filters (rated EU4) - 13 required in total:
019-400-009	250 x 400 x 50 - 5 required
019-400-008	450 x 500 x 50 - 8 required



FILTERS (Washable, aluminium frame, supplied separately)* :

	ISD 465KB Filters (rated EU4) - 6 required in total:
019-000-038	450 x 500 x 50 - 3 required
019-000-040	450 x 600 x 50 - 3 required
	ISD 570/670KB Filters (rated EU4) - 6 required in total:
019-000-033	500 x 500 x 50 - 2 required
019-000-038	450 x 500 x 50 - 4 required
	ISD 840KB Filters (rated EU4) - 8 required in total:
019-000-033	500 x 500 x 50 - 4 required
019-000-038	450 x 500 x 50 - 4 required
	ISD 950KB Filters (rated EU4) - 13 required in total:
019-000-039	250 x 400 x 50 - 5 required
019-000-038	450 x 500 x 50 - 8 required

* NB. These accessories can be field fitted. If accessories are requested to be fitted by **temperzone**, then a stock unit modification fee is applicable to items purchased from stock. This fee does not apply to units made to order. Filter sizes are nominal; refer to Temperzone for actual measurements.

MISCELLANEOUS ACCESSORIES :

201-000-129	Signal Isolator for EC Motor (ie Y models) using 0-10V fan speed control option (provided by t/stat or BMS by others)
201-000-386	Signal Input 0-10V for OSA digital models (UC7) with Controller by others
201-000-105	Fault Indicating Auxilary Relay Board
201-000-037	Electrical Filter
201-000-190	Indoor Coil Sensor Installation Kit
019-000-041	Magnehelic Guage 0–500 Pa
019-500-100	Manometer 0–750 Pa

Controls



ITEM NO. DESCRIPTION

temperzone SAT-3 ROOM TEMPERATURE CONTROLLER :

- 201-000-146 for ISD-KYX/OSA 116–351 (c/w IUC/UC8)
- Accessories:*
- 201-000-074 Interface cable - 10m (4 core shielded twisted pair)
- 201-000-075 Interface cable - 20m (4 core shielded twisted pair)
- 201-000-077 Interface cable - 30m (4 core shielded twisted pair)
- Optional:*
- 201-000-116 Remote Return Air duct sensor c/w 5 m lead
- 201-000-073 Zone Control Kit (2–6 zones)(excl. ISD 87),
2–6 sensors and dampers required
- 201-000-195 Remote Wall Mtd Air Sensor in box, excludes lead,
switchable single or twin bead
- 201-000-047 Sensor lead (excludes sensor) - 6 m
- 221-000-123 Zone Damper 24V 200 dia.
- 221-000-124 Zone Damper 24V 250 dia.
- 221-000-125 Zone Damper 24V 300 dia.
- 221-000-126 Zone Damper 24V 350 dia.

temperzone SAT-2.1 THERMOSTAT KIT :

- 525-001-016 for retro-fitting to 24V single & two stage sys. (incl. 10m interface cable to wall plaque)
suits ISD 380–950 K and OPA 116/161/186/242/294/370/465/550/850/960 RKT
- Optional:*
- 201-000-116 Remote Return Air Duct Sensor c/w 5 m lead
- 201-000-026 Interface Cable (to wall plaque) - 10 m
- 201-000-034 Interface Cable (to wall plaque) - 20 m
- 201-000-063 SAT Infra Red Remote Controller Slimline
- 201-000-024 SAT-2.1 Wall Control plaque (additional)
temperzone Zone Control Kit for SAT-2.1
- 201-000-036 SAT-2 Zone Control Kit
- 201-000-032 Transformer for SAT-2, 230V/10V



temperzone TZT-100 THERMOSTAT :

- for use with units fitted with IUC and/or UC6/UC7/UC8 Controllers, including digitals,
but not suitable four units supplied with Economiser dampers.
- 201-000-350 TZT-100 Wall Plaque (excl. cable)
- Accessories:*
- 201-000-074 Interface cable - 10m (4 core shielded twisted pair)
- 201-000-075 Interface cable - 20m (4 core shielded twisted pair)
- 201-000-077 Interface cable - 30m (4 core shielded twisted pair)
- Optional:*
- 201-000-116 Remote Return Air Duct Sensor c/w 5 m lead
(can only be used as a single sensor, not for averaging)
- 201-000-195 Remote Wall Mtd Air Sensor in box, excludes lead,
switchable single or twin bead
- 201-000-046 Sensor lead (excludes sensor) - 1.5 m
- 201-000-047 Sensor lead (excludes sensor) - 6 m
- 201-000-048 Sensor lead (excludes sensor) - 12 m
- 201-000-049 Sensor lead (excludes sensor) - 25 m
- 201-000-071 Easy Zone Touch (EZT) Wall Plaque
- 201-000-070 Zone Relay Board (EZT) c/w housing

Controls



ITEM NO. DESCRIPTION

temperzone WIFI SERVICE UTILITY (WSU)

for use with units fitted with UC6/UC7/UC8 Controllers

View a unit's operating data using a WiFi connection and web browser on your mobile device. Data is viewed in real time and can be used to record commissioning status and diagnose operational faults. A running history can also be retrieved.

201-000-700 WiFi Service Utility (WSU)



SERVICE INTERFACE DISPLAY (pGDN1)

Operating pressures, superheat, set-point, compressor amps, etc and status can be read from its various display screens, including history. Avoids the need to connect gauges

201-000-867 UC6 Service Interface device (excl. cable)

201-000-378 Communications cable 3m (for the above)



525-001-015

temperzone TZT-701 THERMOSTAT KIT (While stocks last) :

for retro-fitting on ISD/OSA 840,950RKT (non-UC6/UC7/UC8), (24V single & two stage systems)

Accessories & Optional items:

All items as listed above for the TZT-100 Controller

Replacement Parts

ITEM NO. DESCRIPTION

- 201-000-485 UC6 Controller (Twin fixed speed comp.)
– refer temperzone for other variations
- UC8 Controller
– refer tz Tech. Support for appropriate version
- 201-000-100 Outdoor Unit Controller (OUC4)
- 201-000-149 IUC Indoor Unit Controller
- 201-000-101 Sensor (S/valve) - red lead 2m
- 201-000-102 Sensor (HPC) - yellow lead 2m
- 201-000-103 Sensor (De-Ice) - blue lead 2m
- 201-000-110 HP Fan Speed Controller
- 201-191-001 Electronic De-Ice (R22 sys.)
- 201-000-031 SAT-1 Controller board (PCB)
- 201-000-001 SAT-2.1 Controller board (PCB)
- 525-001-014 SAT-2.1 Thermostat Kit 230V
- 525-001-016 SAT-2.1 Thermostat Kit 24V
- 201-000-042 TZT-701 Wall Control plaque

LOKRING – Solder-free Tube Connectors



Tooling

- 460-000-001 LOKbox MZ-V MB 0835
for 6/8/9.5/13/16/19/22/28/35mm dia. pipe
- 460-000-010 LOKtool MB 25 EVP Assembly Jaws (2 req'd) \$67.00 ea.
for 25mm dia. pipe

LOKprep Solution

- 460-000-020 HT 15 ML (use in ambients from 25°C)
- 460-000-021 HT 50 ML " " " " "
- 460-000-022 LT 15 ML (use in ambients up to 30°C)
- 460-000-023 LT 50 ML " " " " "
- 460-000-024 Abrasive mat 3 pack

Straight Brass Connectors

- 460-000-030 6.35 (1/4") NK Ms 50
- 460-000-031 9.53 (3/8") NK Ms 50
- 460-000-032 12.7 (1/2") NK Ms 50
- 460-000-033 16 (5/8") NK Ms 50
- 460-000-034 19 (3/4") NK Ms 50
- 460-000-035 22 (7/8") NK Ms 50
- 460-000-037 28 (1 1/8") NK Ms 50
- 460-000-038 35 (1 3/8") NK Ms 50

Reducer Brass Connectors

- 460-000-064 8.00 / 6.35 NR Ms 50
- 460-000-040 9.53 / 6.35 NR Ms 50
- 460-000-065 9.50 / 8.00 NR Ms 50
- 460-000-041 12.7 / 6.35 NR Ms 50
- 460-000-042 12.7 / 9.53 NR Ms 50
- 460-000-043 16 / 6.35 NR Ms 50
- 460-000-044 16 / 9.53 NR Ms 50
- 460-000-045 16 / 12.7 NR Ms 50
- 460-000-046 19 / 9.53 NR Ms 50
- 460-000-047 19 / 12.7 NR Ms 50
- 460-000-048 19 / 16 NR Ms 50
- 460-000-050 22 / 12.7 NR Ms 50
- 460-000-051 22 / 16 NR Ms 50
- 460-000-052 22 / 19 NR Ms 50
- 460-000-060 28.6 / 16 NR Ms 50
- 460-000-061 28.6 / 19 NR Ms 50
- 460-000-062 28.6 / 22 NR Ms 50
- 460-000-067 35 / 28.6 NR Ms 50

LOKRING – Solder-free Tube Connectors (cont'd)

VULKAN LOKRING



Stabilisation Inserts

460-000-070	6.35 (1/4") - for 0.8 mm walled tube *
460-000-089	8.00 (5/16") - for 0.8 mm wall tube
460-000-073	9.53 (3/8") - for 0.8 mm wall tube *
460-000-076	12.7 (1/2") - for 0.8 mm wall tube
460-000-077	12.7 (1/2") - for 0.9 mm wall tube *
460-000-079	16 (5/8") - for 0.8 mm wall tube *
460-000-080	16 (5/8") - for 1.0 mm wall tube
460-000-081	19 (3/4") - for 1.0 mm wall tube *
460-000-084	19 (3/4") - for 1.1 mm wall tube
460-000-087	22 (7/8") - for 1.1 mm wall tube
460-000-085	22 (7/8") - for 1.4 mm wall tube
460-000-086	28 (1 1/8") - for 1.2 mm wall tube
460-000-090	35 (1 3/8") - for 1.5 mm wall tube

* Use with temperzone Copper Pipe (page12).

Note: To ensure a leak free joint it is important to use a Lokring stabilisation insert designed to match the wall thickness of your copper tube.



Elbow Copper Connectors*

460-000-100	9.35 (3/8") Cu 90° EB
460-000-101	12.7 (1/2") Cu 90° EB
460-000-102	16 (5/8") Cu 90° EB
460-000-103	19 (3/4") Cu 90° EB
460-000-104	22 (7/8") Cu 90° EB
460-000-105	28 (1 1/8") Cu 90° EB
460-000-106	35 (1 3/8") Cu 90° EB

* Complete with inserts but need Straight Brass Connectors for each end (see p.12)

WARRANTY: 12 months on tools.

Packaged Units - Ducted Reverse Cycle



These are single piece, air cooled, roof top units that provide a three phase, ducted, reverse cycle package. The OPA range has been developed to meet the needs of light commercial and retail premises, e.g. offices, motels, restaurants and shops.

These new systems are MEPS compliant and use refrigerant R410A.

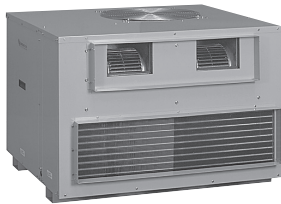

OPA 100-201
(NB no Economiser option)

ITEM NO.	MODEL	NOMINAL COOLING kW	NOMINAL HEATING kW
Single Compressor Systems			
556-051-701	OPA 116RKTYH ⁽⁷⁾	11.6	10.8
556-091-701	OPA 161RKTYH ⁽⁷⁾	16.1	14.4
556-101-701	OPA 186RKTYH ⁽⁷⁾	18.6	16.2
556-111-601	OPA 201RKTYH ⁽⁷⁾	20.0	19.0
Eco Systems (Variable capacity + EC motor/s)			
566-101-701	OPA 186RKTYGH ⁽⁷⁾	7.4~18.6	2.4~16.2
566-111-601	OPA 201RKTYGH ⁽⁷⁾	8.0~20.0	2.7~18.1

Note:
⁽⁷⁾ Complete with UC7 Controller.

OPTIONS
TZZ-100 Controller: refer page 9.

Packaged Units - Ducted Reverse Cycle



Econex are the next generation inverter models, using R32 refrigerant for a lower GWP, and high static EC plug fans and axial fans. Units include electronic expansion valves (EEV).

Opposite handing, Economiser (with or without Viking) and Fresh Air options available.

Refer to Temperzone for further information.

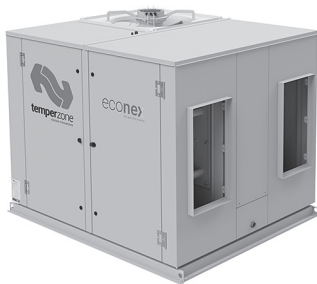

These are single piece, air cooled, roof top units that provide a three phase, ducted, reverse cycle package. The OPA range has been developed to meet the needs of light commercial and retail premises, e.g. offices, motels, restaurants and shops.

These new systems are MEPS compliant and use refrigerant R32.

ITEM NO.	MODEL	NOMINAL COOLING kW	NOMINAL HEATING kW
Single Compressor Systems			
Econex Systems (Inverter variable capacity + EC motor/s)			
876-025-701	OPA 250RLTFPQ01 ⁽⁸⁾	24.6	26.9
876-025-723	OPA 250RLTFPQ23* ⁽⁸⁾	(10.1~29.1)	(6.5~29.3)
876-035-701	OPA 350RLTFPQ01 ⁽⁸⁾	34.8	37.0
876-035-723	OPA 350RLTFPQ23* ⁽⁸⁾	(18.0~45.4)	(13.9~47.0)
876-045-701	OPA 450RLTFPQ01 ⁽⁸⁾	43.3	44.4
876-045-723	OPA 450RLTFPQ23* ⁽⁸⁾	18.2~52.4	16.5~54.5
876-056-701	OPA 560RLTFPQ01 ⁽⁸⁾	53.5	57.0
876-056-723	OPA 560RLTFPQ23* ⁽⁸⁾	(27.4~64.8)	(24.0~63.1)
Econex Systems c/w Economiser (control by others)			
877-025-701	OPA 250RLTFPQ01-Z* ⁽⁸⁾	24.6	26.9
877-025-723	OPA 250RLTFPQ23-Z ⁽⁸⁾	(10.1~29.1)	(6.5~29.3)
877-035-701	OPA 350RLTFPQ01-Z* ⁽⁸⁾	34.8	37.0
877-035-723	OPA 350RLTFPQ23-Z ⁽⁸⁾	(18.0~45.4)	(13.9~47.0)
877-045-701	OPA 450RLTFPQ01-Z* ⁽⁸⁾	43.3	44.4
877-045-723	OPA 450RLTFPQ23-Z ⁽⁸⁾	18.2~52.4	16.5~54.5
877-056-701	OPA 560RLTFPQ01-Z* ⁽⁸⁾	53.5	57.0
877-056-723	OPA 560RLTFPQ23-Z ⁽⁸⁾	(27.4~64.8)	(24.0~63.1)

Note:
* Not a Stock Item
⁽⁸⁾ Complete with UC8 Controller.

OPTIONS
Filters
Drain tundish set
TZZ-100 Controller; refer page 9
CTC-1 Climate Touch Controller (coming soon)
Economiser – with Viking Controller
Fresh Air Cowl

Nomenclature	
OPA Suffixes:	
R	Reverse cycle system
K	Refrigerant R410A
L	Refrigerant R32
T	Three phase power supply
H	Horizontal supply/return air
Y	EC indoor air fan motor
P	EC Plug fan
G	Digital scroll compressor
F	Inverter compressor system
Q	EC outdoor fan
Z	Economiser (excl. controls)
01	Horizontal supply/return air
10	Opposite Hand version
23	Downward supply/return air
32	Opposite Hand version

Packaged Units - Ducted Reverse Cycle



The **Eco** Series provides added economy, flexibility and performance through using variable capacity compressors, high static EC motor plug fan technology and EEV valves (except 186/201). compliant and use refrigerant R32.

ITEM NO.	MODEL	NOMINAL COOLING kW	NOMINAL HEATING kW
866-071-701	OPA 705RKTBG01-P ⁽⁸⁾	14~69.7	13.5~67.5
866-071-723	OPA 705RKTBG23-P *	"	"

Note:

* Not a Stock Item.

⁽⁸⁾ Complete with UC8 Controller.

OPA 705 Eco model has a variable + fixed speed compressor combination.

OPA 855 Eco model includes two variable speed (digital) compressors.

OPTIONS

Filters; refer page 16.

TZT-100 Controller, SAT-3 Controller kit for UC8 models; refer page 9.

Opposite hand versions (OPA 705/855 Eco)

Economiser and/or Viking Controller (OPA 705/855), Fresh Air Kit (OPA 705/855).



Packaged Units - Ducted Reverse Cycle

R32

Econex goes one step further by including Inverter compressors.

These are single piece, air cooled, roof top units that provide a three phase, ducted, reverse cycle package. The OPA range has been developed to meet the needs of light commercial and retail premises, e.g. offices, motels, restaurants, theatres, supermarkets and shopping malls.

These new systems are MEPS compliant and use refrigerant R32.



econex
nex gen R32 inverter

ITEM NO.	MODEL	NOMINAL COOLING kW	NOMINAL HEATING kW
Econex Systems (Inverter + Fixed for variable capacity + EC motor/s)			
866-082-701	OPA 820RLTB1FPQ01 ⁽⁸⁾	11~84	10~87
866-082-723	OPA 820RLTB1FPQ23 ⁽⁸⁾	"	"
866-097-701	OPA 970RLTB1FPQ01 ⁽⁸⁾	15~99	14~96
866-097-723	OPA 970RLTB1FPQ23 ⁽⁸⁾	"	"
866-141-701	OPA 1410RLTM1FPQ01 ⁽⁸⁾	12~189	13~181
866-141-723	OPA 1410RLTM1FPQ23 ⁽⁸⁾	"	"
866-171-701	OPA 1710RLTM1FPQ01 ⁽⁸⁾	17~177	15~182
866-171-723	OPA 1710RLTM1FPQ23 ⁽⁸⁾	"	"
866-211-701	OPA 2110RLTM1FPQ01 ⁽⁸⁾	31~209	15~206
866-211-723	OPA 2110RLTM1FPQ23 ⁽⁸⁾	"	"
Economiser versions (excl. controls):			
867-082-701	OPA 820RLTB1FPQ01-Z ⁽⁸⁾	11~84	10~87
867-082-723	OPA 820RLTB1FPQ23-Z ⁽⁸⁾	"	"
867-097-701	OPA 970RLTB1FPQ01-Z ⁽⁸⁾	15~99	14~96
867-097-723	OPA 970RLTB1FPQ23-Z ⁽⁸⁾	"	"
867-141-701	OPA 1410RLTM1FPQ01-Z ⁽⁸⁾	12~189	13~181
867-141-723	OPA 1410RLTM1FPQ23-Z ⁽⁸⁾	"	"
867-171-701	OPA 1710RLTM1FPQ01-Z ⁽⁸⁾	17~177	15~182
867-171-723	OPA 1710RLTM1FPQ23-Z ⁽⁸⁾	"	"
867-211-701	OPA 2110RLTM1FPQ01-Z ⁽⁸⁾	31~209	15~206
867-211-723	OPA 2110RLTM1FPQ23-Z ⁽⁸⁾	"	"



Econex Pro Systems (Inverter variable capacity + EC motor/s) *

876-097-701	OPA 970RLTB2FPQD01 ⁽⁸⁾	16~102	13~110
876-097-723	OPA 970RLTB2FPQD23 ⁽⁸⁾	"	"
876-141-701	OPA 1410RLTM4FPQD01 ⁽⁸⁾	12~190	12~190
876-141-723	OPA 1410RLTM4FPQD23 ⁽⁸⁾	"	"
876-171-701	OPA 1710RLTM4FPQD01 ⁽⁸⁾	15~206	15~214
876-171-723	OPA 1710RLTM4FPQD23 ⁽⁸⁾	"	"
876-211-701	OPA 2110RLTM4FPQD01 ⁽⁸⁾	27~239	15~244
876-211-723	OPA 2110RLTM4FPQD01 ⁽⁸⁾	"	"
Economiser versions (incl. controls):			
877-097-701	OPA 970RLTB2FPQ01-Z ⁽⁸⁾	16~102	13~110
877-097-723	OPA 970RLTB2FPQ23-Z ⁽⁸⁾	"	"
877-141-701	OPA 1410RLTM4FPQ01-Z ⁽⁸⁾	12~190	12~190
877-141-723	OPA 1410RLTM4FPQ23-Z ⁽⁸⁾	"	"
877-171-701	OPA 1710RLTM4FPQ01-Z ⁽⁸⁾	115~206	15~214
877-171-723	OPA 1710RLTM4FPQ23-Z ⁽⁸⁾	"	"
877-211-701	OPA 2110RLTM4FPQ01-Z ⁽⁸⁾	27~239	15~244
877-211-723	OPA 2110RLTM4FPQ23-Z ⁽⁸⁾	"	"

Econex units use a mix of inverter + fixed compressors, and using R32 refrigerant for a lower GWP.

More suited to external BMS control applications.

Economiser (-Z) models include dampers c/w motors and cowl; no controls.

Econex Pro units include a sophisticated Carel c.pCO programmed logic controller and four inverters.

Particularly suited to supermarkets and process applications where humidity control is important.

Made to order. Refer to Temperzone for further information.

* Start-up Commissioning by Temperzone is a warranty requirement on Econex Pro models, and varies dependant on location of install.

⁽⁸⁾ Complete with UC8 slave controllers.

OPTIONS

Filters (p.16), TZT-100 Thermostat for Econex model only (excl. -Z variant) (p.9), Remote Service Interface Device (pGD1) for Econex Pro (p.18).

Options:

Opposite hand versions, Reheat coil versions, Economiser version (NB controls by others on Econex model). Economiser & Spill Air (Bottom Return Air configurations only).

<i>Nomenclature</i>	
OPA Suffixes:	
R	Reverse cycle system
K	Refrigerant R410A
L	Refrigerant R32
T	Three phase power supply
B	Dual compressor system
M	Multiple compressor system
P	EC Plug fan
G	Digital scroll compressor
F	Inverter compressor system
D	Advanced controller
Q	EC outdoor fans
Z	Economiser (excl. controls)
01	Horizontal supply/return air
10	Opposite Hand version
23	Downward supply/return air
32	Opposite Hand version

Packaged Systems – Accessories

ITEM NO.	DESCRIPTION
	<u>FILTERS (Disposable, supplied separately)* :</u>
019-400-005	OPA 250 Filters (rated EU4) : Filter size 600 x 500 x 50 - 2 required
019-400-001	OPA 350 Filters (rated EU4) - 3 required in total: Filter size 600 x 300 x 50 - 1 required
019-400-005	Filter size 600 x 500 x 50 - 2 required
019-400-004	OPA 450 Filters (rated EU4) : Filter size 500 x 500 x 50 - 4 required
019-400-005	OPA 560 Filters (rated EU4) : Filter size 600 x 500 x 50 - 4 required
019-400-008	OPA 705 Filters (rated EU4) Filter size 450 x 500 x 50 - 9 required
019-400-004	OPA 820, 970 Filters (rated EU4) Filter size 500 x 500 x 50 - 9 required
019-400-005	OPA 1410 Filters (rated EU4) - 9 required in total: Filter size 600 x 500 x 50 - 3 required
019-400-007	Filter size 600 x 600 x 50 - 6 required
019-400-005	OPA 1710 Filters (rated EU4) - 12 required in total: Filter size 600 x 500 x 50 - 12 required
019-400-004	OPA 2110 Filters (rated EU4) - 16 required in total: Filter size 500 x 500 x 50 - 12 required
019-400-005	Filter size 600 x 500 x 50 - 12 required

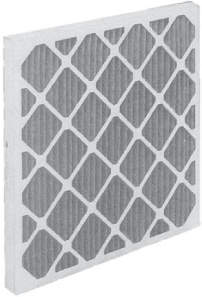

	<u>FILTERS (Washable, aluminium frame, supplied separately)*</u>
019-000-034	OPA 250 Filters (rated EU4) : Filter size 600 x 500 x 50 - 2 required
019-000-037	OPA 350 Filters (rated EU4) - 3 required in total: Filter size 600 x 300 x 50 - 1 required
019-000-034	Filter size 600 x 500 x 50 - 2 required
019-000-033	OPA 450 Filters (rated EU4) : Filter size 500 x 500 x 50 - 4 required
019-000-034	OPA 560 Filters (rated EU4) : Filter size 600 x 500 x 50 - 4 required
019-000-038	OPA 705 Filters (rated EU4) Filter size 450 x 500 x 50 - 9 required
019-000-033	OPA 820, 970 Filters (rated EU4) Filter size 500 x 500 x 50 - 9 required
019-000-034	OPA 1410 Filters (rated EU4) - 9 required in total: Filter size 600 x 500 x 50 - 3 required
019-000-031	Filter size 600 x 600 x 50 - 6 required
019-000-034	OPA 1710 Filters (rated EU4) - 12 required in total: Filter size 600 x 500 x 50 - 12 required
019-000-033	OPA 2110 Filters (rated EU4) - 16 required in total: Filter size 500 x 500 x 50 - 12 required
019-000-034	Filter size 600 x 500 x 50 - 4 required



	<u>ANTI-VIBRATION MOUNTS (Rubber) :</u>
060-000-170	for OPA 116–201 (set of 4)
	<u>CONDENSATE DRAIN TUNDISH (25 OD/21 ID) :</u>
060-000-653	for OPA 250–560, 970 outdoor section (set of 2)

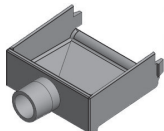
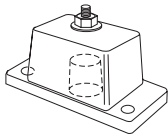

* **Note:** These accessories are for fitting in the field.
Filter sizes are nominal; refer to Temperzone for actual measurements.

Packaged Systems – Accessories (cont'd)

ITEM NO. DESCRIPTION



201-000-867

SERVICE INTERFACE DISPLAY (pGDN1)

Wired remote for OPA units with *Carel c.pCO* Controller. Up to 50m separation using telephone cable (RJ11), or up to 200m using AWG24 shielded cable and card adaptor (not supplied). Setpoint, humidity, schedule, operating pressures, superheat, compressor amps, alarms, etc and status can be read from its various display screens, including history. No need to connect gauges.

Service Interface Display (excl. cable)



VIKING CONTROLLER (factory fitted)

for OPA units with economisers/variable capacity fans and/or compressors
SMT-920 Viking Controller (Factory fitted only)
c/w Outdoor Temperature/Humidity sensor fitted and Room Temp. t/stat supplied loose

Optional:
Air Quality Sensor (CO₂ sensor)



201-000-700

WIFI SERVICE UTILITY (WSU)

for use with units fitted with UC6/UC7/UC8 Controllers

View a unit's operating data using a WiFi connection and web browser on your mobile device. Data is viewed in real time and can be used to record commissioning status and diagnose operational faults. A running history can also be retrieved.

WiFi Service Utility (WSU)

Vertical Packaged Units - Ducted Reverse Cycle



The VPA is designed to operate in cold South Island conditions; down to -15°C. Features a digital compressor for variable capacity and an EC plug fan with 0-10V control, low start-up current and on-site adjustable fan inlet/outlet positions.

ITEM NO.	MODEL	NOMINAL COOLING kW	NOMINAL HEATING kW
520-291-011	VPA 160RKTGV	2~16.1	2~16.2

Note:

Not a stock item. Includes UC8 and TZT-100 Controller. BMS connectivity via Modbus or RS425.

OPTIONS

- Cabinet colour to suit
- Different filter types
- Water heating module

Not a Stock Item. Made to order.



Packaged Units - Ducted Water Cooled



The low profile **HWP** Series ducted water cooled packaged air conditioners are ideal for multi-unit installations such as high-rise offices, hotels, apartments and multiple-tenancies. Compact and reliable, these units can be installed above ceiling, or in other concealed spaces, saving valuable floor space and providing conditioned air direct to necessary locations.

The units are designed to be used with simple, short duct layouts.

HWP 36–275 models include high efficiency ThermoShell® technology for improved non-fouling water properties and greater range of water supply temperatures and water flows.

HWP 36–275 (UC8) models are compatible with the optional SAT-3 or TZT-100 Room Thermostats. UC8 controller based models have the ability to connect to water circulating pumps and flow control valves, so when the unit is cooling a signal will control the valve to obtain an optimum condensing pressure and temperature (and only when needed thereby reducing pump running costs). UC8 also supplies operating conditions and fault codes to TZZ-100 or BMS systems.

These new systems are MEPS compliant, ie they meet the Minimum Energy Performance Standards set out in AS/NZS 3823.2:2013 and use refrigerant R410A.

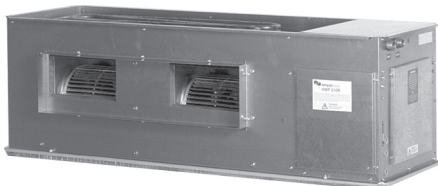
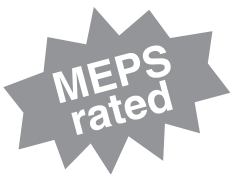
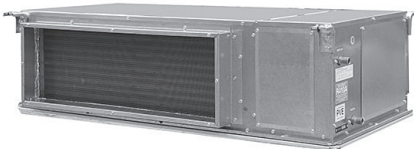

ITEM NO.	MODEL	NOMINAL COOLING kW	NOMINAL HEATING kW
<u>COOLING WITH ELECTRIC HEAT:</u>			
509-036-102	HWP 36CEKS ⁽⁸⁾	3.5	2.0
509-048-102	HWP 48CEKS ⁽⁸⁾	4.4	2.0
509-059-102	HWP 59CEKS ⁽⁸⁾	5.9	3.0
509-079-102	HWP 79CEKS ⁽⁸⁾	8.1	4.0
509-098-102	HWP 98CEKS ⁽⁸⁾	9.9	4.0
509-118-102	HWP 118CEKT ⁽⁸⁾	12.2	6.0
509-142-102	HWP 142CEKT ⁽⁸⁾	14.7	6.0
509-172-102	HWP 172CEKT ⁽⁸⁾	18.5	9.0
509-192-102	HWP 192CEKT ⁽⁸⁾	21.2	9.0
509-255-102	HWP 255CEKT ⁽⁸⁾ *	25.5	12.0
509-275-102	HWP 275CEKT ⁽⁸⁾ *	27.5	12.0
508-591-201	HWP 370CEKTN *	36.6	18.0
508-631-201	HWP 445CEKTN *	44.5	24.0
<u>REVERSE CYCLE:</u>			
509-036-001	HWP 36RKS ⁽⁸⁾	3.5	3.6
509-048-001	HWP 48RKS ⁽⁸⁾	4.4	4.6
509-059-001	HWP 59RKS ⁽⁸⁾	5.9	5.4
509-079-001	HWP 79RKS ⁽⁸⁾	8.1	8.9
509-098-001	HWP 98RKS ⁽⁸⁾	9.9	11.1
509-118-001	HWP 118RKT ⁽⁸⁾	12.2	11.9
509-142-001	HWP 142RKT ⁽⁸⁾	14.7	14.8
509-172-001	HWP 172RKT ⁽⁸⁾	18.5	16.4
509-192-001	HWP 192RKT ⁽⁸⁾	21.2	18.6
509-255-001	HWP 255RKT ⁽⁸⁾ *	25.5	23.3
509-275-001	HWP 275RKT ⁽⁸⁾ *	27.5	24.5
507-581-201	HWP 370RKTN *	36.7	34.9
507-621-201	HWP 445RKTN *	44.5	42.2

Note:

* **Not a Stock Item; made-to-order.**

⁽⁸⁾ Includes UC8 controller. BMS connectivity via Modbus/RS485 port.

Optional SAT-3 Room Thermostat (HWP 36–275 only) (refer p.21)

Optional TZZ-100 Room Thermostat (HWP 36-275) (refer p.21)

Above models are complete with spring mounts.

Filters (rated EU2/G2) are supplied on HWP 36–275 models only; a filter-integrated R/A spigot (Filter Box) is available for all other models.

Water hoses included: HWP 36–142 models 600 mm lg, HWP 172–275 800mm lg.

HWP 370/445 units **do not** include water hoses.

HWP 36–98 models require single phase power supply; HWP 118+ require three phase.

HWP 370/445 models require a 230 volt controller (not available from Temperzone).

Opposite Hand versions available.

Refer page 30 for Accessories.

<p><i>Nomenclature</i></p> <p>HWP Suffixes:</p> <p>R – Reverse cycle system</p> <p>C – Cooling only system</p> <p>E – Electric heat</p> <p>K – Refrigerant R410A</p> <p>S – Single phase power supply</p> <p>T – Three phase power supply</p> <p>F – Inverter compressor</p>
--

Packaged Units - Ducted Water Cooled



HWP*Y Eco models include high efficiency EC motors and therefore have higher EER/COP ratings. Fan speed can be variably controlled directly by a BMS system, via a 0–10V signal.

The low profile HWP Series ducted water cooled packaged air conditioners are ideal for multi-unit installations such as high-rise offices, hotels, apartments and multiple-tenancies. Compact and reliable, these units can be installed above ceiling, or in other concealed spaces, saving valuable floor space and providing conditioned air direct to necessary locations.

The units are designed to be used with simple, short duct layouts.

HWP 36–275 models include high efficiency ThermoShell® technology for improved non-fouling water properties and greater range of water supply temperatures and water flows.

HWP 36–275 (UC8) models are compatible with the optional SAT-3 or TZT-100 Room Thermostats. UC8 controller based models have the ability to connect to water circulating pumps and flow control valves, so when the unit is cooling a signal will control the valve to obtain an optimum condensing pressure and temperature (and only when needed thereby reducing pump running costs). UC8 also supplies operating conditions and fault codes to TZT-100 or BMS systems.

These new systems are MEPS compliant, ie they meet the Minimum Energy Performance Standards set out in AS/NZS 3823.2:2013 and use refrigerant R410A.

ITEM NO.	MODEL	NOMINAL COOLING kW	NOMINAL HEATING kW
COOLING WITH ELECTRIC HEAT:			
510-036-102	HWP 36CEKSY *	3.5	2.0
510-048-102	HWP 48CEKSY *	4.4	2.0
510-059-102	HWP 59CEKSY *	5.9	3.0
510-079-102	HWP 79CEKSY *	8.1	4.0
510-098-102	HWP 98CEKSY *	9.9	4.0
510-118-102	HWP 118CEKTY *	12.2	6.0
510-142-102	HWP 142CEKTY *	14.7	6.0
510-172-102	HWP 172CEKTY *	18.5	9.0
510-192-102	HWP 192CEKTY *	21.2	9.0
510-255-102	HWP 255CEKTY *	25.5	12.0
510-275-102	HWP 275CEKTY *	27.5	12.0
REVERSE CYCLE:			
510-036-001	HWP 36RKSYS	3.5	3.7
510-048-001	HWP 48RKSYS	4.4	4.6
510-059-001	HWP 59RKSYS	5.9	5.4
510-079-001	HWP 79RKSYS	8.1	8.9
510-098-001	HWP 98RKSYS	9.9	11.3
510-118-001	HWP 118RKTY	12.2	11.6
510-142-001	HWP 142RKTY	14.7	14.5
510-172-001	HWP 172RKTY	18.5	16.7
510-192-001	HWP 192RKTY	21.2	18.6
510-255-001	HWP 255RKTY *	25.5	23.3
510-275-001	HWP 275RKTY *	27.5	24.5

Note:

* Not a Stock Item; made-to-order.

Includes UC8 controller. BMS connectivity via Modbus/RS485 port.

Optional SAT-3 Room Thermostat (refer p.21)

Optional TZT-100 Room Thermostat (refer p.21)

Above models are complete with spring mounts.

Filters (rated EU2/G2) are supplied.

Water hoses included: HWP 36–142 models 600 mm lg, HWP 172–275 800mm lg.

HWP 36–98 models require single phase power supply; HWP 118+ require three phase.

Opposite Hand versions available.

Refer page 31 for Accessories.

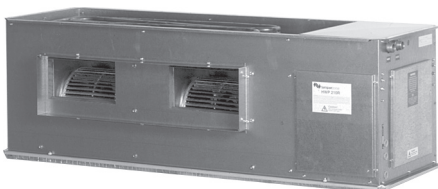
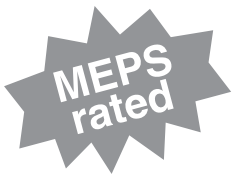
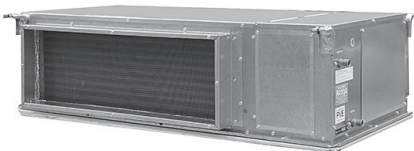

<p><i>Nomenclature</i></p> <p>HWP Suffixes:</p> <p>R – Reverse cycle system</p> <p>C – Cooling only system</p> <p>E – Electric heat</p> <p>K – Refrigerant R410A</p> <p>S – Single phase power supply</p> <p>T – Three phase power supply</p> <p>F – Inverter compressor</p> <p>Y – EC motor</p>

Packaged Units - Ducted Water Cooled - Accessories

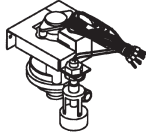

ITEM NO.	MODEL
	CONDENSATE LIFT-PUMP KIT:
507-003-009	for HWP 36-59
507-003-010	for HWP 79-275
507-003-011	for HWP 370, 445

ITEM NO.	MODEL	PRICE
	FILTERS (washable synthetic fibre EU2/G2):	
119-000-049	for HWP 370 - 2 required	\$ 39 ea.
119-000-050	for HWP 445 - 2 required	\$ 41 ea.



ITEM NO.	MODEL	DESCRIPTION
201-000-146		temperzone SAT-3 ROOM TEMPERATURE CONTROLLER :
201-000-074		for HWP 36-275 (c/w UC8)
201-000-075		Interface cable - 10m (4 core shielded twisted pair)
201-000-077		Interface cable - 20m (4 core shielded twisted pair)
		Interface cable - 30m (4 core shielded twisted pair)
		Refer page 12 for sensor and other accessories.



ITEM NO.	MODEL	DESCRIPTION
201-000-350		temperzone TZT-100 THERMOSTAT :
201-000-074		for HWP 36-275 (c/w UC8)
201-000-075		Interface cable - 10m (4 core shielded twisted pair)
201-000-077		Interface cable - 20m (4 core shielded twisted pair)
		Interface cable - 30m (4 core shielded twisted pair)
		Refer page 10 for sensor accessories.

SPARE PARTS

201-000-023	HWP Protection Board
201-000-412	UC8 Controller 24V (Hydronics)

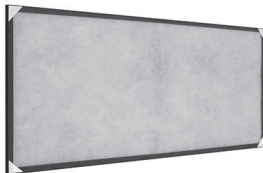

ITEM NO.	MODEL	DESCRIPTION
		REPLACEMENT FILTER (washable synthetic fibre EU2/G2):
119-000-098		for HWP 36, 48
119-000-086		for HWP 59
119-000-084		for HWP 79, 98
119-000-097		for HWP 118
119-000-099		for HWP 142
119-000-100		for HWP 172
119-000-103		for HWP 192
119-000-104		for HWP 255
119-000-105		for HWP 275 - 2 required

WARRANTY

Standard Warranty as per General Conditions of Sale (page 4)

Packaged Units - Ducted Water Cooled **R32**



CWP Econex model is a closet version of the HWP, but with a variable capacity inverter compressor and built-in water pump. They include high efficiency EC motors. Fan speed can be variably controlled directly by a BMS system, via a 0-10V signal.

ITEM NO.	MODEL	NOMINAL COOLING kW	NOMINAL HEATING kW
573-009-002	CWP 90RELSFY	4.1~10.0	3.7~8.9

REVERSE CYCLE WITH ELECTRIC HEAT:



Note:
Not a Stock Item; made-to-order.
 Includes UC8 controller. BMS connectivity via Modbus/RS485 port.
 Optional TZT-100 Room Thermostat (refer p.29)(Not suitable for SAT-3).
 Filters (rated EU2/G2) are supplied.
 Water hoses included: 600 mm lg.
 Requires single phase power supply.



The CWP Series ducted water cooled packaged air conditioners are ideal for multi-unit installations such as high-rise offices, hotels, apartments and multiple-tenancies. The units are designed to be used with simple, short duct layouts.

CWP 90 model includes high efficiency Thermoshell® technology with non-fouling water properties and a wide range of water supply temperatures and water flows. Electric elements are included in the air stream as a backup for when supply water temperature is too low.

CWP 90 (c/w UC8) can be connected to water circulating pumps and flow control valves, so when the unit is cooling a signal will control the valve to obtain an optimum condensing pressure and temperature (and only when needed thereby reducing pump running costs). UC8 supplies operating conditions and fault codes to TZT-100 or BMS systems.

These new systems are MEPS compliant, ie they meet the Minimum Energy Performance Standards set out in AS/NZS 3823.2:2013 and use refrigerant R32 which has a low GWP.

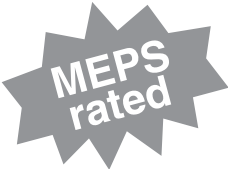

Chilled Water Fan Coil Units (IMDL Series)

Fan coil units are an integral part of an overall air conditioning system where the energy transfer medium (i.e. chilled or hot water) is circulated by a central plant facility.

temperzone offers an extensive range of ducted fan coil units. A variety of options and accessories are available to meet most air conditioning requirements.

Low operating cost, energy efficient fan motors are used in all units. Easy installation and maintenance add to the cost effectiveness of temperzone IMDL Series fan coil units.

New IMDL 'Y' versions include high efficiency EC motors with higher static performance and optional 0-10V speed control.



ITEM NO.	MODEL	NOMINAL AIR FLOW	ELECTRIC HEAT
313-171-001	IMDL 40-H 3/1	205 l/s	–
313-371-001	IMDL 60-H 3/1	335 l/s	–
313-571-001	IMDL 90-H 3/1	480 l/s	–
313-771-001	IMDL 130-H 3/1	650 l/s	–

c/w ELECTRIC HEAT (instead of heating coil; w/o SSR) :

313-151-006	IMDL 40-H 4E	205 l/s	1.5 kW
313-351-006	IMDL 60-H 4E	335 l/s	2 kW
313-551-006	IMDL 90-H 4E	480 l/s	3 kW
313-751-006	IMDL 130-H 4E	650 l/s	4 kW

c/w EC MOTORS :

313-171-701	IMDL 40Y 3/1	200 l/s	
313-371-701	IMDL 60Y 3/1	325 l/s	
313-571-701	IMDL 90Y 3/1	400 l/s	
313-771-701	IMDL 130Y 3/1	700 l/s	

c/w EC MOTOR & ELECTRIC HEAT* (instead of heating coil; c/w SSR) :

313-151-806	IMDL 40Y 4E	205 l/s	1.5 kW
313-351-806	IMDL 60Y 4E	335 l/s	2 kW
313-551-806	IMDL 90Y 4E	400 l/s	3 kW
313-751-806	IMDL 130Y 4E	650 l/s	4 kW

Note:

All of the above units are Stock Items.

Units are right handed and fitted with: high (-H) capacity or EC (-Y) motors, return air plenum and filter.

* EC motor versions with elec. heat come with SSR using 24V ac control (customer supplied)

ACCESSORIES (Supplied separately)

FLEXIBLE HOSES:

for Heating coil, all models:

060-000-629 13 FPT (1/2") 600mm lg 3000psi

for Cooling coil, IMDL 40/60:

060-000-630 20 FPT (3/4") 600mm lg 1500psi

for Cooling coil, IMDL 90/130:

060-000-631 25 FPT (1") 800mm lg 1500psi

MULTI-OUTLET SPIGOT:

313-001-007 for IMDL 40 (200 dia. x 2)

313-201-007 for IMDL 60 (250 dia. x 2)

313-401-007 for IMDL 90 (250 dia. x 3)

313-601-007 for IMDL 130 (250 dia. x 4)

REPLACEMENT FILTERS (rated EU2) :

119-128-001 for IMDL 40 (545 x 236)

119-129-001 for IMDL 60 (795 x 236)

119-130-001 for IMDL 90 (1045 x 243)

119-131-001 for IMDL 130 (725 x 243) - 2 req'd

Note:

Fan coil units are also available Made-to-Order with the following options:

Standard, Medium or High capacity motors (for non-EC motor versions)

3 row Cooling + 1 row Heating

3 row or 4 row Cooling Only, with or without Electric Heat.

Standard Multi-Outlet Spigot

Left or Right handed

Electric Heat with solid state relay (SSR) for non-EC motor versions



IXDL Series

Incorporating multiple EC fans (1 to 5) within each unit, IXDL multi-zone fan coil units allows you to set different temperatures for different rooms within the same building simultaneously. IXDL units are made-to-order. Refer your temperzone representative for more info. or visit www.temperzone.biz

Chilled Water Fan Coil Units (IMD Series)

Fan coil units are an integral part of an overall air conditioning system where the energy transfer medium (i.e. chilled or hot water) is circulated by a central plant facility.

temperzone offers an extensive range of ducted fan coil units. A variety of options and accessories are available to meet most air conditioning requirements.

Low operating cost, energy efficient fan motors are used in all units. Easy installation and maintenance add to the cost effectiveness of temperzone IMD Series fan coil units.

New IMD 'Y' versions include high efficiency EC motors with higher static performance and optional 0-10V speed control.



ITEM NO.	MODEL	NOMINAL AIR FLOW
315-311-001	IMD 95 4/1	450 l/s
315-381-001	IMD 135 4/1	600 l/s
315-451-001	IMD 170 4/1	750 l/s
315-521-001	IMD 210 4/1	900 l/s
315-591-001	IMD 280 4/1	1250 l/s
315-661-001	IMD 420 4/1 *	1800 l/s
315-731-001	IMD 550 4/1 *	2340 l/s
<u>EC motor versions:</u>		
315-311-601-SPE	IMD 95Y 4/1	450 l/s
315-381-601-SPE	IMD 135Y 4/1	600 l/s
315-451-601-SPE	IMD 170Y 4/1	750 l/s
315-521-601-SPE	IMD 210Y 4/1	900 l/s
315-591-601-SPE	IMD 280Y 4/1	1250 l/s
315-661-601-SPE	IMD 420Y 4/1	1800 l/s
315-731-601-SPE	IMD 550Y 4/1	2340 l/s

Note:

* Not a Stock Item.

Coils are 4 row cooling + 1 row heating

IMD(Y) fan coil units are also available with the following coil configurations:

4 - Four row for cooling or heating

4/E - Four row cooling + electric heat

12 Months Parts & Labour Warranty; Extended Warranty available

ACCESSORIES (Supplied separately)

FILTER BOX c/w filter rated EU2/G2 :

325-121-005	for IMD 95
325-231-005	for IMD 135
325-271-005	for IMD 170
325-311-005	for IMD 210
325-351-005	for IMD 280
325-431-005	for IMD 420
325-591-005	for IMD 550

SPRING MOUNTING KIT :

307-161-101	for IMD 95-420 (No.2)
307-341-101	for IMD 550 (No.3)

FLEXIBLE HOSES:

060-000-629	for Heating coil, IMD 95-210: 13 FPT (1/2") 600mm lg 3000psi
060-000-631	for Cooling coil, IMD 95-210 25 FPT (1") 800mm lg 1500psi
060-000-631	for Heating coil, IMD 280: 25 FPT (1") 800mm lg 1500psi
060-000-632	for Cooling coil, IMD 280-550: 32 FPT (1 1/4") 1300mm lg 1000psi
060-000-632	for Heating coil, IMD 420, 550: 32 FPT (1 1/4") 1300mm lg 1000psi

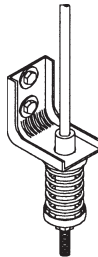
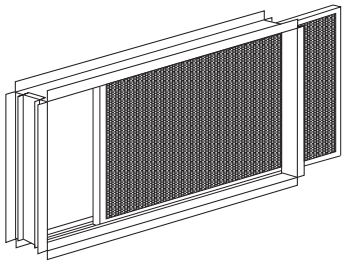

Chilled Water Fan Coil Units (GMW Series)

GMW fan coil units are an integral part of an overall air conditioning system where the energy transfer medium (i.e. chilled or hot water) is circulated by a central plant facility.

These underceiling models are ideal for fixed ceiling installations, don't take up valuable wall space and are relatively easy to relocate. Suitable for use in department stores, offices, classrooms, institutions, etc.

Low operating cost, energy efficient fan motors are used in all units. Easy installation and maintenance add to the cost effectiveness of **temperzone** GMW Series fan coil units.



ITEM NO.	MODEL	NOMINAL AIR FLOW
318-141-001	GMW 50-H 2/1	175 l/s
318-191-001	GMW 70-H 2/1	240 l/s
318-281-001	GMW 80-H 2/1	375 l/s
318-401-001	GMW 140-H 2/1	625 l/s
318-491-001	GMW 160-H 2/1	815 l/s

Note:

All of the above units are stock items.
 GMW fan coil units are also available with the following options:
 Standard or High capacity motors
 2 row Cooling + 1 row Heating
 3 row Cooling

Chilled Water Air Handling Units (IJD Series)

Air Handling units are an integral part of an overall air conditioning system where the energy transfer medium (i.e. chilled or hot water) is circulated by a central plant facility.

temperzone offers an extensive range of belt driven ducted air handling units. A variety of options and accessories are available to meet most air conditioning requirements.

Low operating cost, energy efficient fan motors are used in all units. Easy installation and maintenance add to the cost effectiveness of temperzone IJD Series air handling units.

temperzone also offers an extensive range of robust custom made air handling units under the Clever brand, up to 23,500 l/s (MC Series).

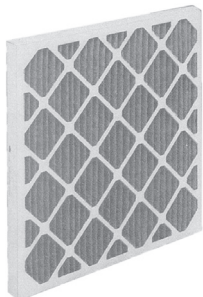
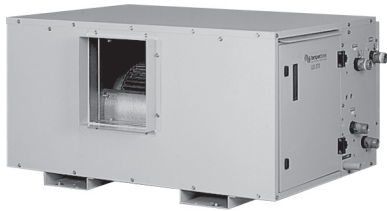

MODEL	NOMINAL AIR FLOW
IJD 370	1500 l/s
IJD 450	1800 l/s
IJD 620	2400 l/s
IJD 950	3600 l/s
IJD 1400	5500 l/s
IJD 2000	7200 l/s
IJD 2400	9300 l/s

Note:

All IJD units are Made-to-Order.
Horizontal or vertical supply air versions available.

Coil configurations available are:

- 4 - Four row for cooling or heating
- 4/1 - Four row cooling / one row heating
- 4/E - Four row cooling + electric heat
- 6 - Six row for cooling or heating
- 6/1 - Six row cooling / one row heating
- 6/E - Six row cooling + electric heat
- 1 - One row for heating
- E - Electric Heat only (no coil)

OPTIONS

- Filters
- Polyester powder coat finish (Gull Grey).
- EC Plug fan versions

FILTERS (disposable, rated EU4) :

	for IJD 370
019-400-005	600 x 500 x 50 - 2 required
	for IJD 450
019-400-003	625 x 400 x 50 - 3 required
	for IJD 620
019-400-006	625 x 500 x 50 - 3 required
	for IJD 950 - 6 required in total
019-400-002	400 x 500 x 50 - 3 required
019-400-004	500 x 500 x 50 - 3 required
	for IJD 1400 - 8 required in total
019-400-008	450 x 500 x 50 - 4 required
019-400-004	500 x 500 x 50 - 4 required
	for IJD 2000
019-400-004	500 x 500 x 50 - 12 required
	for IJD 2400
019-400-005	500 x 600 x 50 - 12 required

Chilled Water Air Handling Units (MT Series)



Air Handling units are an integral part of an overall air conditioning system where the energy transfer medium (i.e. chilled or hot water) is circulated by a central plant facility.

MT Series units feature EC Plug fans and a light weight aluminium frame, thermal break panels and separable fan coil/plenum sections. A variety of options and accessories are available to meet most air conditioning requirements.

Energy efficient fan motors are used in all units. Easy installation and maintenance add to the cost effectiveness of Temperzone MT Series air handling units.

Temperzone also offers an extensive range of robust custom made air handling units, up to 23,500 l/s (MC Series).

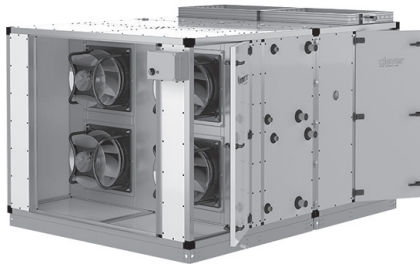

MODEL	NOMINAL AIR FLOW
MT 030	750 l/s
MT 060	1 500 l/s
MT 120	3 000 l/s
MT 180	5 000 l/s
MT 270	7 500 l/s
MT 360	10 000 l/s
MT 450	12 500 l/s
MT 540	15 000 l/s

Note:

All MT units are Made-to-Order on relatively short lead times
Horizontal or vertical supply air versions available, as well as LH/RH versions.

Coil configurations available are:

- 2 - Two row heating
- 4 - Four row for cooling or heating
- 4/1 - Four row cooling / one row heating
- 6 - Six row for cooling or heating
- 6/1 - Six row cooling / one row heating
- 8 - Eight row cooling

OPTIONS

Filters: G4 panels, F7 bags or F9 cartridges.
Polyester powder coat finish (Titania).
Return air/outside air mixing dampers.
Magnahelic guage, internal lighting, inspection window.
MC Series – custom built range.

Heat Pump Water Heaters



MWS Potable units are Single Pass systems providing 62°C hot water. Use **R32** low GWP refrigerant. An in-built BDLC pump is included. Liquid injection compressor technology is standard for improved performance at low ambient conditions.

Rating conditions: 7/6 °C db/wb outdoor ambient; EWT 30°C; LWT 45°C

MWH Space Heating units include variable capacity inverter compressors – enabling close temperature control. Use **R32** low GWP refrigerant. A pump is optional. EVI version (V) is recommended for improved performance at low ambient conditions.

Rating conditions: 7/6 °C db/wb outdoor ambient; EWT 30°C; LWT 45°C

MWU Underfloor units include a variable capacity inverter compressor – enabling close temperature control. Inverters provide additional economy at part load. Uses R410A refrigerant. Includes integrated BDLC pump (8m head).

Rating conditions: 7/6 °C db/wb outdoor ambient; EWT 25°C; LWT 35°C

MWP Pool units include a titanium Thermoshell®. Use R410A refrigerant. TZT-100 Controller supplied. A pump is not included.

Rating conditions: 25/18 °C db/wb outdoor ambient; EWT 25°C; LWT 28°C

Suffix Nomenclature	
K	Refrigerant R410A
L	Refrigerant R32
S	Single phase power supply
T	Three phase power supply
M	Multiple compressors
P	Internal Pump
C	Advanced Controller (PLC)
E	EC Condenser fans
V	Electronic Vapour Injection (EVI)

Application Optimised Heat Pumps

Features:

- Designed and manufactured for reliability and durability by Temperzone in NZ.
- Highly efficient, cost effective integrated water heating systems
- Fouling resistant ThermoShell® heat-exchanger
- In-line inverter systems for space heating and cooling for maximum energy savings
- Elimination of intermediate buffer tanks
- Powerful yet quiet, compact design
- Integrated 'turnkey' controls for suitable applications (eg LAT Control with MWH)
- Integrated BLDC (variable speed) pump on some models
- Local support and commissioning
- BMS / Modbus connectivity

As all systems are application optimised. Contact temperzone for info on how to apply these models.

ITEM NO.	DESCRIPTION	NOMINAL HEATING kW	CAPACITY RANGE kW
POTABLE MODELS (SINGLE PASS):			
<u>Three Phase:</u>			
503-025-005	MWS 250LT	20.0	
503-050-005	MWS 500LTM	40.0	
503-100-005	MWS 1000LTM	74.0	
SPACE HEATING MODELS:			
<u>Three Phase:</u>			
503-090-501	MWH 900LTM-PC	77.5	22.3 ~ 91.9
503-090-511	MWH 900LTM-C (w/o pump)		
503-090-505	MWH 900LTM-PCV	89.3	21 ~ 105
503-090-515	MWH 900LTM-CV (w/o pump)		
503-200-505	MWH 2000LTM-CE (wop)	140.0	14 ~ 205
503-200-515	MWH 2000LTM-CEV (wop)	154.3	14 ~ 224
UNDERFLOOR MODELS:			
<u>Single Phase:</u>			
502-018-101	MWU 180KS	15.8	3.8 ~ 19.5
<u>Three Phase:</u>			
502-025-101	MWU 250KT	19.5	4.7 ~ 19.5
502-045-101	MWU 450KT	37.0	8.9 ~ 48.5
<u>Accessories:</u>			
349-000-975	Expansion Tank, Statico SD 8.3, 8L		
POOL HEATING MODELS:			
<u>Single Phase:</u>			
502-023-201	MWP 230KS	26.0	
<u>Three Phase:</u>			
502-025-201	MWP 250KT	27.5	
502-040-201	MWP 400KT	42.5	
ACCESSORY (All models):			
060-000-437	Drain Adaptor Kit (25OD/21ID)		



MAGNUS

MAGNUS

Note

Commissioning by Temperzone. Complete our Sales Enquiry form prior to ordering.

WARRANTY 2 years Parts & Labour.

Also available: pumps, expansion & storage tanks, auto-fill kit, water flow valves.

Radial Swirl Diffusers

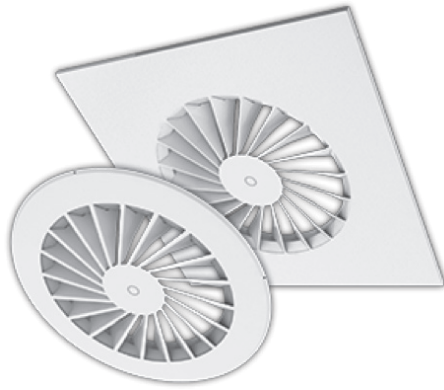

ITEM NO.	DESCRIPTION
	<u>SMARTEMP® Range (Fixed Helical):</u>
122-600-001	HSC-FD-DN355-S595 355 dia. White 595 mm Square, lay-in half tile, excl. plenum
122-935-150	Side entry plenum, Ø150 spigot *
122-935-200	Side entry plenum, Ø200 spigot
122-935-250	Side entry plenum, Ø250 spigot
122-935-300	Side entry plenum, Ø300 spigot
122-600-002	HSC-FD-DN500-S595 500 dia. White 595 mm Square, lay-in half tile, excl. plenum
122-950-250	Side entry plenum, Ø250 spigot
122-950-300	Side entry plenum, Ø300 spigot
122-950-350	Side entry plenum, Ø350 spigot
122-950-400	Side entry plenum, Ø400 spigot *
122-600-011	HSC-FD-DN355-C500 355 dia. White Round, 500 mm OD, excl. plenum
122-600-012	HSC-FD-DN500-C710 500 dia. White Round, 710 mm OD, excl. plenum

Note:
* Made-to-order
Collars, 2-way and 3-way inserts; made-to-order.

Ask your **temperzone** representative about other *SmarTemp®* products available.



ISF-AD
Floor Swirl Outlet



CNW-AD
Circular Nozzle Outlet



PMW-AD
Perforated Mainstream Diffuser



LMC-AD
Linear Mainstream Ceiling Diffuser

RPD - Round Plastic Ceiling Diffusers

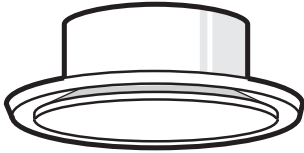

ITEM NO.	DESCRIPTION	SIZE (mm)
133-000-150	Round Plastic Diffuser	150 dia.
133-000-200	Round Plastic Diffuser	200 dia.
133-000-250	Round Plastic Diffuser	250 dia.

Grilles

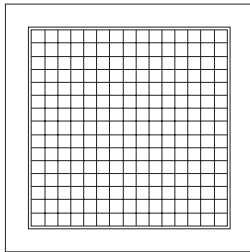

ITEM NO.	DESCRIPTION	SIZE (mm)	COLOUR
121-106-150	EGC-5	150 x 150	White
121-106-200	EGC-5	200 x 200	White
121-106-250	EGC-5	250 x 250	White
121-106-300	EGC-5	300 x 300	White
121-106-400	EGC-5	400 x 400	White
121-106-550	EGC-5 lay-in	550 x 550	White
121-201-300	EGC-5 / HF *	300 x 300	White
121-201-400	EGC-5 / HF *	400 x 400	White
121-201-512	EGC-5 / HF * lay-in	512 x 512	White
121-900-450	EGC-5 / HF	900 x 450	White
119-088-001	Filter only	300 x 300	
119-090-001	Filter only	400 x 400	
119-087-001	Filter only	512 x 512	
119-089-001	Filter only	850 x 400	

* HF - Hinged Frame, including filter.

Adaptors for Grilles

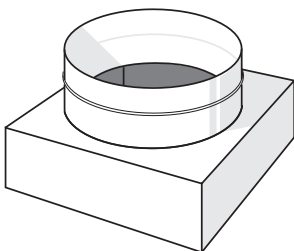

ITEM NO.	MODEL	SIZE (mm)
122-030-060	A15	150 sq. to 150 dia.
122-030-061	A20	200 sq. to 150/200 dia.
122-030-073	A30 *	300 sq. to 200/250 dia.
122-033-005	A33 *	300 sq. to 300 dia.
121-400-040	A40	400 sq. to 300/350 dia.
121-400-011	A51a	512 sq. to 250/300 dia.
121-400-001	A51	512 sq. to 350/400 dia.
121-400-012	A55a	550 sq. to 250/300 dia.
121-400-002	A55	550 sq. to 350/400 dia.
121-900-451	A90	900 x 450. to 2 x 350 dia.

All adaptors are made of black plastic, except A90 which is metal.

Flexiduct

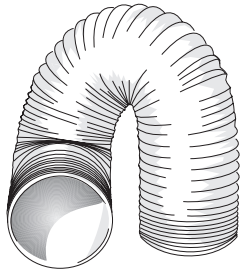

ITEM NO.	DESCRIPTION	SIZE	LENGTH
128-000-021	Flexiduct - Nude	150 mm dia.	3 m
128-000-022	Flexiduct - Nude	200 mm dia.	3 m
128-000-023	Flexiduct - Nude	250 mm dia.	3 m
128-000-024	Flexiduct - Nude	300 mm dia.	3 m
128-000-121	Flexiduct - Insulated	150 mm dia.	3 m
128-000-122	Flexiduct - Insulated	200 mm dia.	3 m
128-000-123	Flexiduct - Insulated	250 mm dia.	3 m
128-000-124	Flexiduct - Insulated	300 mm dia.	3 m
128-000-125	Flexiduct - Insulated	350 mm dia.	3 m
128-000-126	Flexiduct - Insulated	400 mm dia.	3 m
128-000-222	Flexiduct - Insulated	200 mm dia.	6 m
128-000-223	Flexiduct - Insulated	250 mm dia.	6 m
128-000-224	Flexiduct - Insulated	300 mm dia.	6 m
128-000-225	Flexiduct - Insulated	350 mm dia.	6 m
128-000-226	Flexiduct - Insulated	400 mm dia.	6 m

Note:

Above sizes are all stock items.

Flexiduct has been tested at a NATA/Telarc certified laboratory to AS 4254 and complies with NZ Building Code - Fire Safety Amendment Regulations (April 2013).

Duct Tape



ITEM NO.	DESCRIPTION
127-000-040	Duct Sealing Tape - 48 mm x 30 m - Plastic
127-000-042	Duct Sealing Tape - 48 mm x 30 m - Silver Polyprop.

Duct Joiners



ITEM NO.	DESCRIPTION	SIZE (mm)
127-000-001	Duct Joiner	150 dia.
127-000-002	Duct Joiner	200 dia.
127-000-003	Duct Joiner	250 dia.
127-000-004	Duct Joiner	300 dia.
127-000-005	Duct Joiner	350 dia.

Galvanised steel construction.

Air Regulating Damper (TRD Series)

Dimensions

Width: 300–2000 mm
Height: 200– 1200 mm

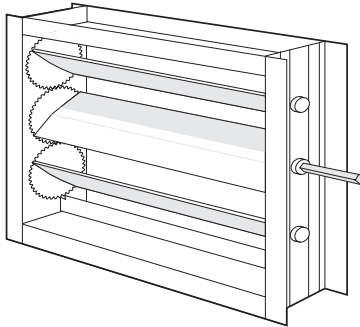

Note:

All dampers are opposed blade rotation only.
One axle and actuator mounting plate per damper is included.
Mill finish only.
Not a Stock Item. Manufactured to order.

OPTIONS

- Electric actuators
- Multiple section dampers to cover larger sizes than tabled above
- Polyester powder coat or anodised finish
- Locking Quadrant (factory fitted)

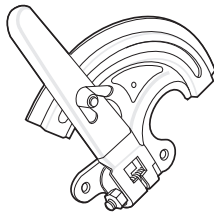

In-Line Centrifugal Fans

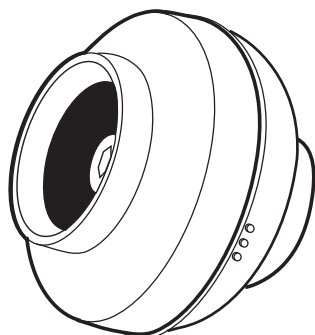

ITEM NO.	MODEL	DIA. (mm)	SPEED R.P.M.
084-002-001	AXC 100B	100	2400
084-005-001	AXC 150A	150	2500
084-007-001	AXC 200A	200	2550
084-009-001	AXC 250	250	2650
084-010-001	AXC 315A	315	2650



ITEM NO.	DESCRIPTION	DIA. (mm)
084-005-002	Duct Clamp	150
084-007-002	" "	200
084-009-002	" "	250
084-010-002	" "	315

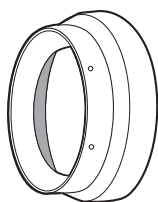

084-010-003	AXC 315-300 adaptor	315
-------------	---------------------	-----

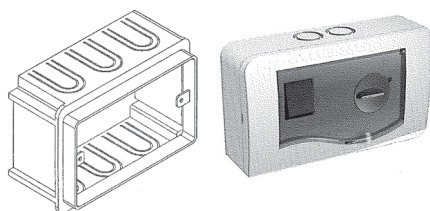

084-001-005	AXC Electronic Controller R15
084-001-006	AXC Electronic Controller - flush box



Circulating Water Pumps

HVAC Application: Hot-water heating systems of all kinds, air-conditioning applications, industrial circulation systems.

Glandless Pumps. Powerful, energy-efficient, easy-maintenance, reliable

ZRS & Star – suited to residential and light commercial applications; sanitary circulators; bronze



ZRS



Stratos PICO-Z

Varios – The most compatible replacement solution for all applications thanks to it's revolutionary design and the Sync function, which allows the installer to duplicate the previous pump settings into the new pump



Varios



ITEM NO.	DESCRIPTION
	ZRS (Sanitary)
070-000-484	ZRS 15/6 Ku P (Replaces previous model Intec Z)
	Stratos PICO-Z (Sanitary)
070-001-033	Stratos PICO-Z 25/1-6
070-001-034	Stratos PICO-Z 20/1-6 (Replaces previous model Star Z)
	Varios PICO
070-001-005	Varios PICO 15/1-7
070-001-004	Varios PICO 25/1-7
070-001-037	Varios PICO 25/1-7-130 Other sizes available
	Unions:
349-000-832	20mm Steel Unions
349-000-825	25mm Cast Iron Unions
349-000-831	32mm Cast Iron Unions
349-000-829	15mm Bronze Unions
349-000-833	20mm Bronze Unions
349-000-827	25mm Bronze Unions
349-000-830	32mm Bronze Unions

WARRANTY 2 Years Parts only.

Visit www.wilo.com for Wilo pump replacement guide [here](#) or contact Temperzone for assistance.



Circulating Water Pumps

HVAC Application: Hot-water heating systems of all kinds, air-conditioning applications, industrial circulation systems.

Glandless Pumps. Powerful, energy-efficient, easy-maintenance, reliable

Yonos – particularly suited to radiators or underfloor heating



TOP-Z – hot-water heating systems of all kinds, air-conditioning systems, closed cooling circuits, industrial circulation systems.

Bronze housing.



ITEM NO.	DESCRIPTION	INFO LINK *
Yonos MAXO		
070-001-006	Yonos MAXO 25/0.5-7	2120639
070-001-009	Yonos MAXO 25/0.5-10	2120640
070-001-007	Yonos MAXO 25/0.5-12	2120641
070-001-010	Yonos MAXO 30/0.5-7	2120642
070-001-011	Yonos MAXO 30/0.5-10	2120643
070-001-032	Yonos MAXO 30/0.5-12	2120644
070-001-604	Yonos MAXO 40/0.5-8 PN6/10	2120646
070-001-605	Yonos MAXO 40/0.5-12 PN6/10	2120647
070-001-606	Yonos MAXO 40/0.5-16 PN6/10	2120648
070-001-607	Yonos MAXO 50/0.5-8 PN6/10	2120649
070-001-608	Yonos MAXO 50/0.5-12 PN6/10	2120651
070-001-609	Yonos MAXO 65/0.5-9 PN6/10	2120653
070-001-610	Yonos MAXO 65/0.5-12 PN6/10	2120654
070-001-611	Yonos MAXO 80/0.5-6 PN10	2120657
070-001-612	Yonos MAXO 80/0.5-12 PN10	2120659
070-001-613	Yonos MAXO 100/0.5-12 PN10	2120661
Yonos MAXO-Z (Sanitary)		
070-001-043	Yonos MAXO-Z 25/0.5-7 PN10	2175538
070-001-042	Yonos MAXO-Z 25/0.5-10 PN10	2175539
070-001-003	Yonos MAXO-Z 30/0.5-7 PN10	2175540
070-001-002	Yonos MAXO-Z 30/0.5-12 PN10	2175541
TOP-Z (Sanitary)		
070-001-082	TOP-Z 25/6 (3~) PN10	2045522
070-001-080	TOP-Z 25/10 (3~) PN10	2175509
070-001-084	TOP-Z 30/7 (3~) PN10	2048341
070-001-086	TOP-Z 30/10 (3~) PN6/10	2175512
070-001-087	TOP-Z 40/7 (3~) PN6/10	2175516
070-001-088	TOP-Z 50/7 (3~) PN6/10	2175522

* Click Article number for detailed product info from Wilo.com

WARRANTY 2 Years Parts only.

Visit www.wilo.com for Wilo pump replacement guide [here](#) or contact Temperzone for assistance.

Circulating Water Pumps



TOP-S – hot-water heating systems of all kinds, air-conditioning systems, closed cooling circuits, industrial circulation systems.

Cast Iron housing.



ITEM NO.	DESCRIPTION	INFO LINK **
TOP-S *		
070-001-113	TOP-S 25/7 (3~) PN10	2048321
070-001-114	TOP-S 25/10 (3~) PN10	2165521
070-001-115	TOP-S 25/13 (1~) PN10	2084440
070-001-116	TOP-S 25/13 (3~) PN10	2084441
070-001-118	TOP-S 30/4 (3~) PN10	2084012
070-001-120	TOP-S 30/7 (3~) PN10	
070-001-121	TOP-S 30/10 (3~) PN10	
070-001-122	TOP-S 40/4 (1~) PN6/10	
070-001-123	TOP-S 40/4 (3~) PN6/10	
070-001-125	TOP-S 40/7 (1~) PN6/10	
070-001-126	TOP-S 40/7 (3~) PN6/10	
070-001-127	TOP-S 40/10 (1~) PN6/10	
070-001-136	TOP-S 50/10 (3~) PN6/10	
070-001-137	TOP-S 50/15 (3~) PN6/10	
070-001-138	TOP-S 65/7 (1~) PN6/10	
070-001-139	TOP-S 65/7 (3~) PN6/10	
070-001-140	TOP-S 65/10 (3~) PN6/10	
070-001-141	TOP-S 65/13 (3~) PN6/10	
070-001-142	TOP-S 65/15 (3~) PN6/10	
070-001-144	TOP-S 80/7 (3~) PN6	
070-001-145	TOP-S 80/10 (3~) PN6	
070-001-146	TOP-S 80/15 (3~) PN6	
070-001-147	TOP-S 100/10 (3~) PN6	

* Check with availability with Temperzone Sales prior to ordering.

** Click Article number for detailed product info from Wilo.co

WARRANTY 2 Years Parts only.

Visit www.wilo.com for Wilo pump replacement guide [here](#) or contact Temperzone for assistance.

Pre-Insulated Pipe



Application: Thermal energy distribution, domestic hot and cold water piping; potable or geothermal. Flexible and easy to install.

Safest choice with homogeneous welding, one material, for increased reliability.

Electro-fusion weldable fittings or compression joiner system.

Range of connector fittings



ITEM NO.	DESCRIPTION	MIN. BEND RADIUS
Flexalen 600 pipe – single (casing/insert):		
029-000-446	Single 125/63 OD	0.8m
029-000-447	Single 160/75 OD	0.8m
029-000-448	Single 160/90 OD	1.0m
029-000-449	Single 200/110 OD	1.25m
029-000-453	End Cap - rubber 125/32–75 OD	
029-000-450	End Cap - rubber 160/50–90 OD	
029-000-463	End Cap - rubber 200/110 OD	
Flexalen 600 pipe – twin (casing/insert):		
029-000-464	Twin 125/2x25 OD	0.6m
029-000-465	Twin 125/2x32 OD	0.6m
029-000-466	Twin 160/2x40 OD	0.8m
029-000-467	Twin 160/2x50 OD	0.8m
029-000-451	Twin 200/2x63 OD	1.25m
029-000-452	End Cap - rubber 125 / 2x25 OD or 2x32 OD	
029-000-454	End Cap - rubber 160 / 2x40 or 2x50 OD	
029-000-455	End Cap - rubber 200 / 2x63 OD	
Electro-fusion Joiner Parts:		
060-000-508	Coupler OD025	
060-000-509	Coupler OD032	
060-000-510	Coupler OD040	
060-000-511	Coupler OD050	
060-000-512	Coupler OD063	
060-000-513	Coupler OD075	
060-000-514	Coupler OD090	
060-000-515	Coupler OD110	
029-000-406	Elbow OD025 90°	
029-000-407	Elbow OD032 90°	
029-000-408	Elbow OD040 90°	
029-000-409	Elbow OD050 90°	
029-000-410	Elbow OD063 90°	
029-000-411	Elbow OD075 90°	
029-000-412	Elbow OD090 90°	

Pre-Insulated Pipe (cont'd)



ITEM NO. DESCRIPTION

Electro-fusion Joiner Parts (cont'd):



- 029-000-413 Elbow OD110 45°
- 029-000-414 Elbow OD110 90°
- 029-000-415 Elbow OD 32 45°
- 029-000-416 Elbow OD 40 45°
- 029-000-417 Elbow OD 50 45°
- 029-000-418 Elbow OD 63 45°
- 029-000-419 Elbow OD 75 45°
- 029-000-420 Elbow OD 90 45°



- 029-000-421 T 90° Equal OD 32
- 029-000-422 T 90° Equal OD 40
- 029-000-424 T 90° Equal OD 50
- 029-000-425 T 90° Equal OD 63
- 029-000-426 T 90° Equal OD 75
- 029-000-427 T 90° Equal OD 90
- 029-000-428 T 90° Equal OD 110



- 029-000-430 Reducer OD 32 > OD 25
- 029-000-431 Reducer OD 40 > OD 32
- 029-000-432 Reducer OD 50 > OD 40
- 029-000-433 Reducer OD 63 > OD 40
- 029-000-434 Reducer OD 63 > OD 32
- 029-000-435 Reducer OD 63 > OD 50
- 029-000-436 Reducer OD 75 > OD 63
- 029-000-437 Reducer OD 90 > OD 63
- 029-000-438 Reducer OD 90 > OD 75
- 029-000-441 Reducer OD 110 > OD 63
- 029-000-442 Reducer OD 110 > OD 75
- 029-000-443 Reducer OD 110 > OD 90



63 mm:



- 060-000-519 Flange Adaptor* GF-BUNDBU63
- 060-000-504 Flange Backing Ring GP-LOSF63-10
- 060-000-521 Flange Seal GF-BUNDBU63

75 mm:



- 060-000-522 Flange Adaptor* GF-BUNDBU75
- 060-000-505 Flange Backing Ring GP-LOSF75-10
- 060-000-524 Flange Seal GF-BUNDBU75

90 mm:

- 060-000-525 Flange Adaptor* GF-BUNDBU90
- 060-000-506 Flange Backing Ring GP-LOSF90-10
- 060-000-527 Flange Seal GF-BUNDBU90

* To be used in conjunction with an Electrofusion Joiner Part

Pre-Insulated Pipe (cont'd)



ITEM NO. DESCRIPTION

Electro-fusion Joiner Parts (cont'd):

110 mm:



- 060-000-528 Flange Adaptor* GF-BUNDBU110
- 060-000-507 Flange Backing Ring GP-LOSF110-10
- 060-000-530 Flange Seal GF-BUNDBU110

* To be used in conjunction with an Electrofusion Joiner Part

Compression Fittings:



- 029-000-400 BCA OD 25 Male 2.3mm (C)
- 029-000-401 BCA OD 32 Male 3.0mm
- 029-000-402 BCA OD 40 Male 3.7mm
- 029-000-403 BCA OD 50 Male 4.6mm
- 029-000-404 BCA OD 63 Male 5.8mm

Radiators (Econorad®)

High performance 'custom made' radiators are constructed from flat rectangular tubing which has low water resistance providing quick and uniform heat up.

Output 150W up to 10,850W.

Thermostatic Radiator Valves by Heimeier®.

More info. [click here](#).

Boilers by De Dietrich® & Gassero®

Gas Condensing and electric models – floor standing and wall hung types

Natural gas, oil or electric.

More info. [click here](#).

HITACHI

Air Conditioning Units (Split Systems)

An extensive range of residential and commercial product types available including: wall mounts, floor mounts, ducted, cassettes, underceiling, multi-zone and VRF.

A separate product catalogue is available on request, or visit www.hitachiaircon.co.nz



Materials and specifications are subject to change without notice due to the manufacturer's ongoing research and development programme.